

VENTANA ABISAGRADA SERIE 6000 RT	DIMENSION	RESULTADO			CERTIFICADO
		AIRE	AGUA	VIENTO	
	1200 x 1200 Alumarte	CLASE	CLASE	CLASE	ARCO TECNOS
		3	E-750	C4	
SIMULACIÓN UNE EN ISO 10077-2:2003	COEFICIENTE DE TRANSMISIÓN TÉRMICA	"U" = 3.1		CIDEMCO	

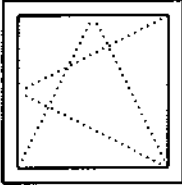

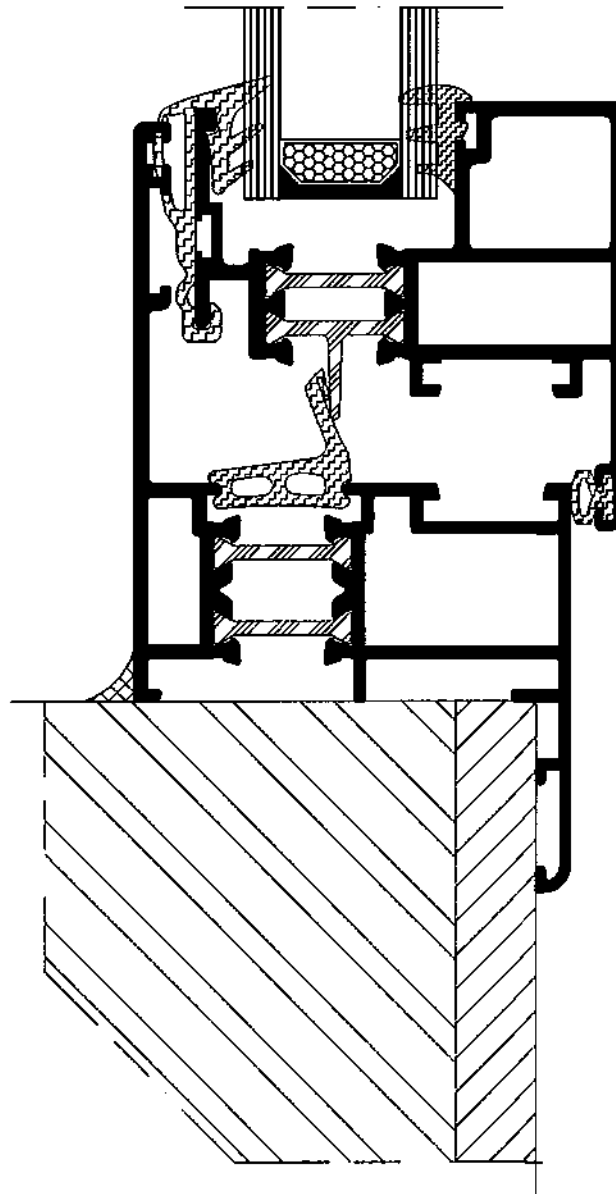

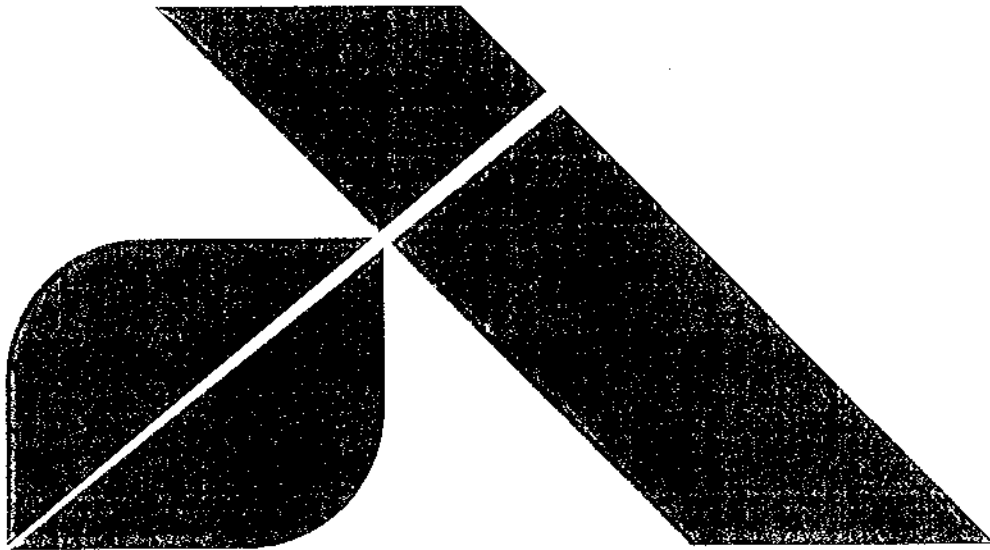
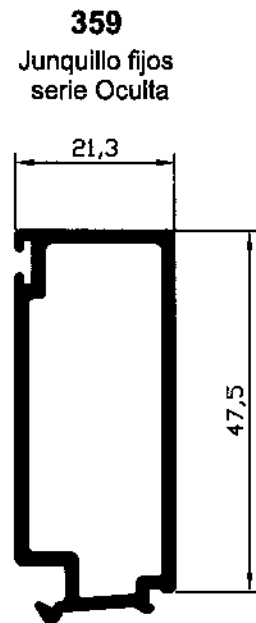
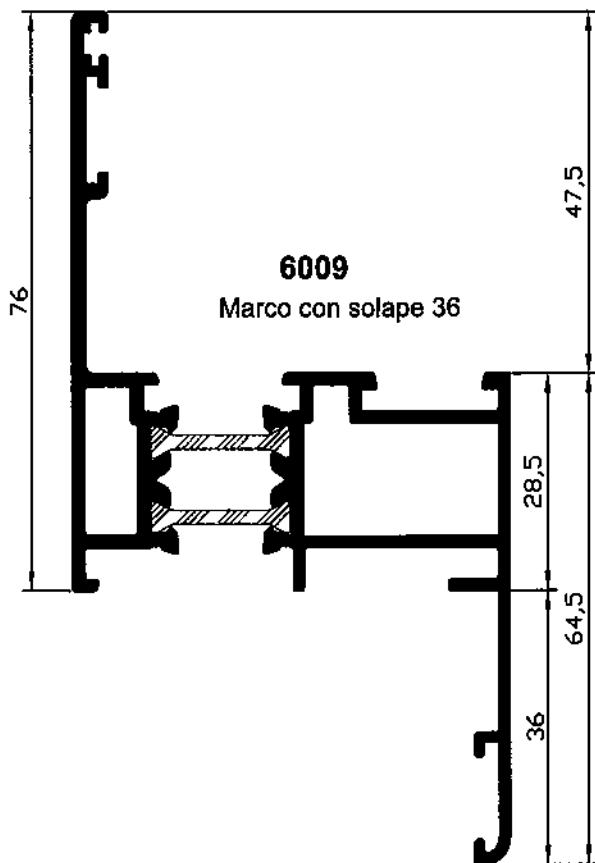
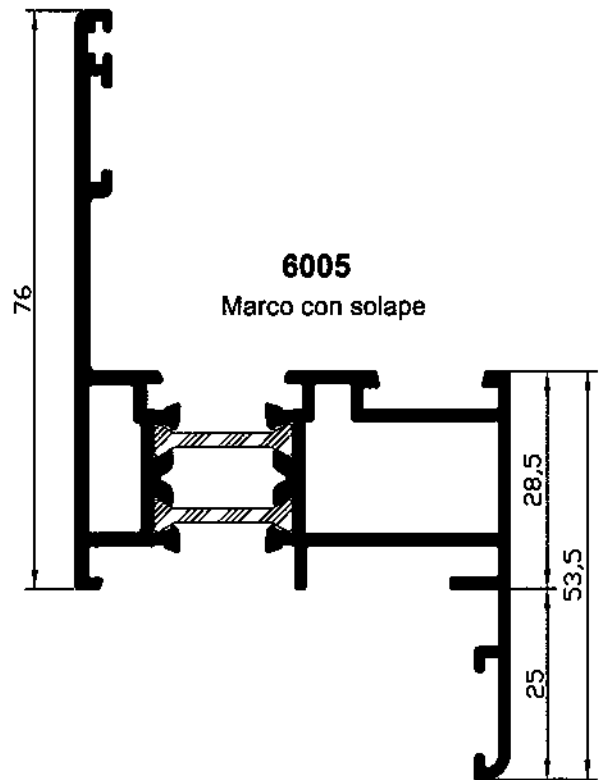
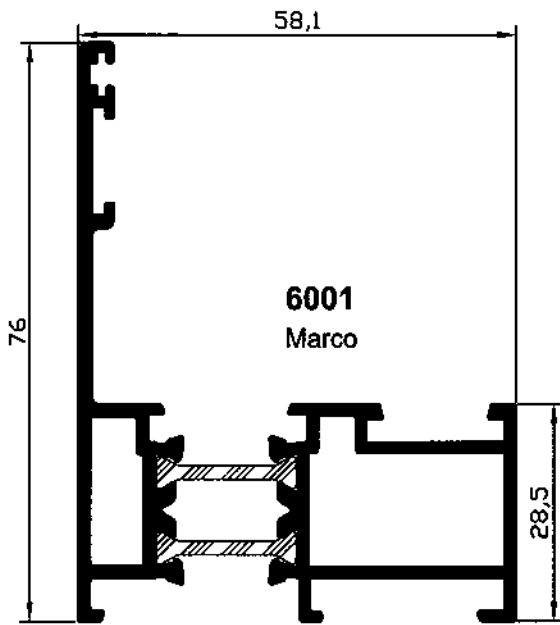

* NOTA: Perfiles solo para 1 hoja.

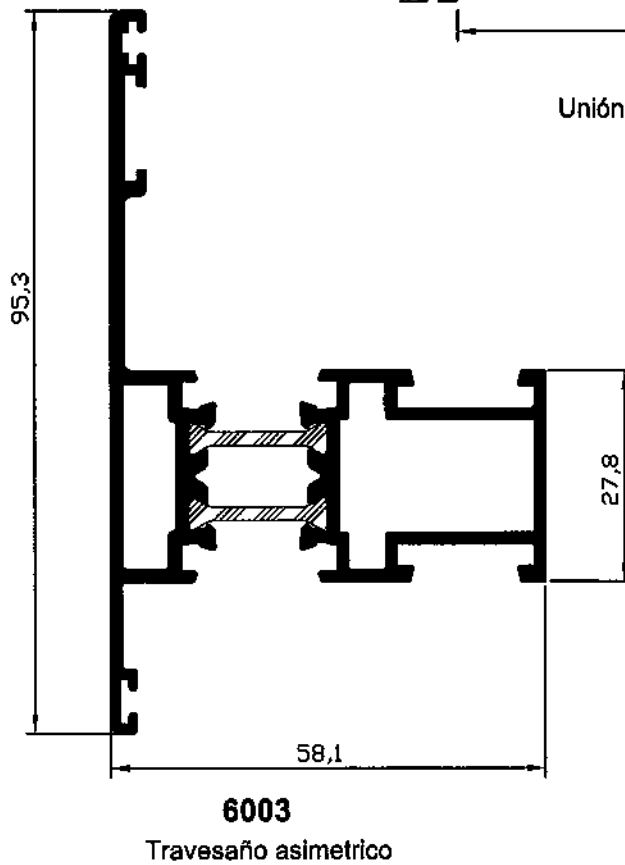
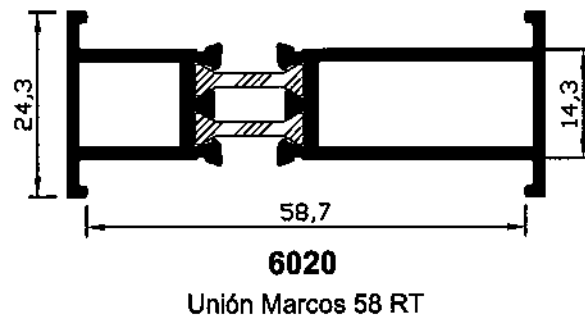
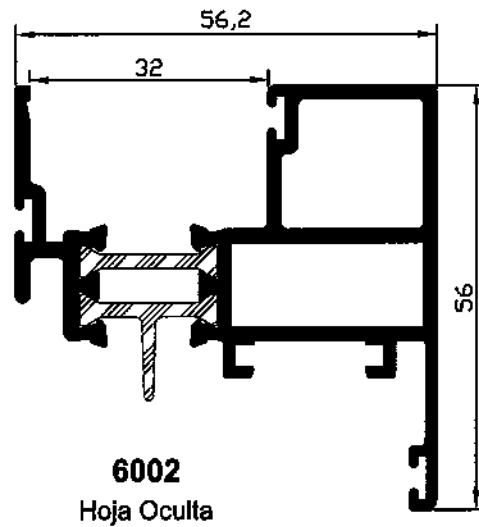



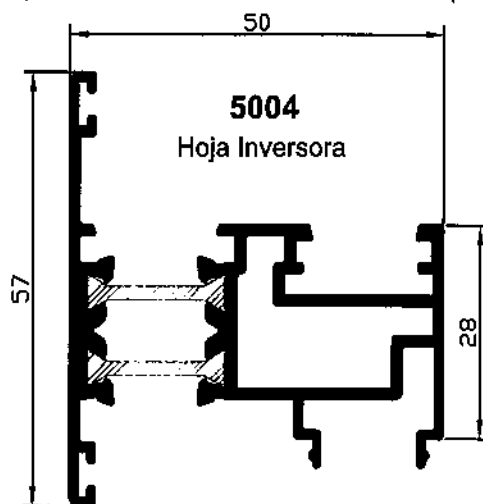
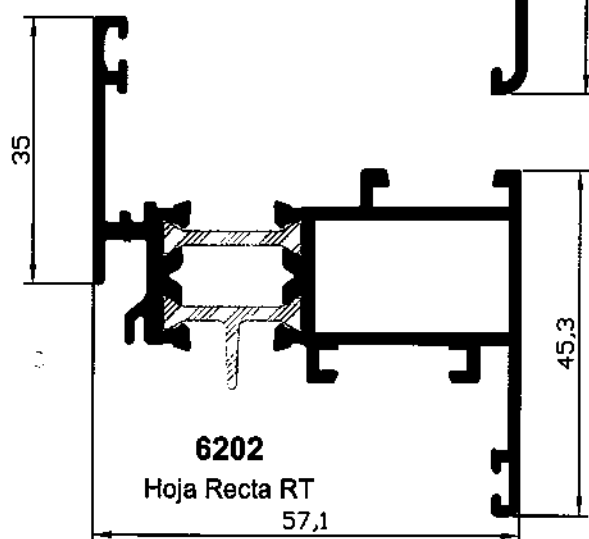
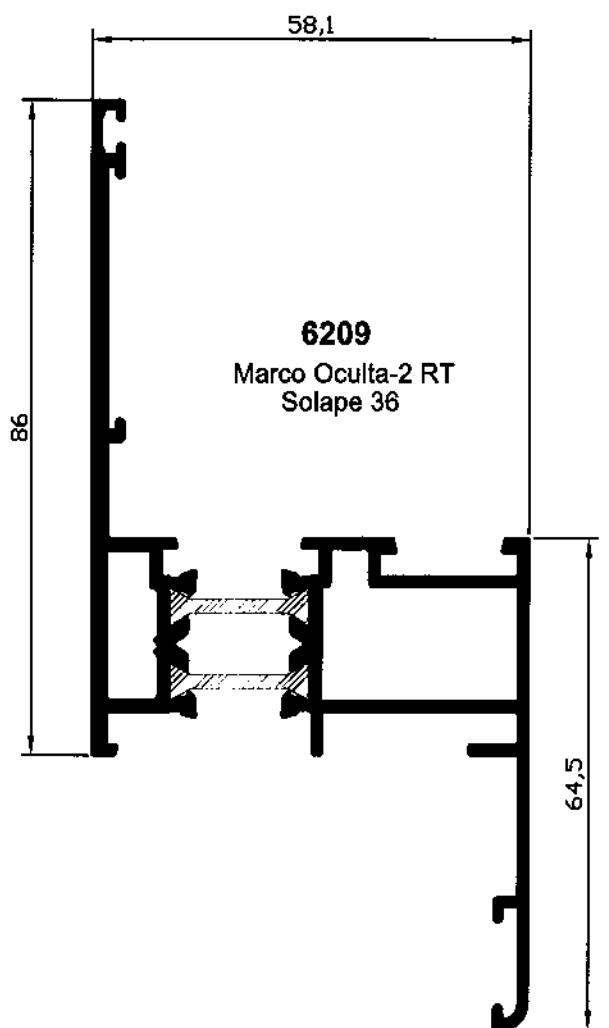
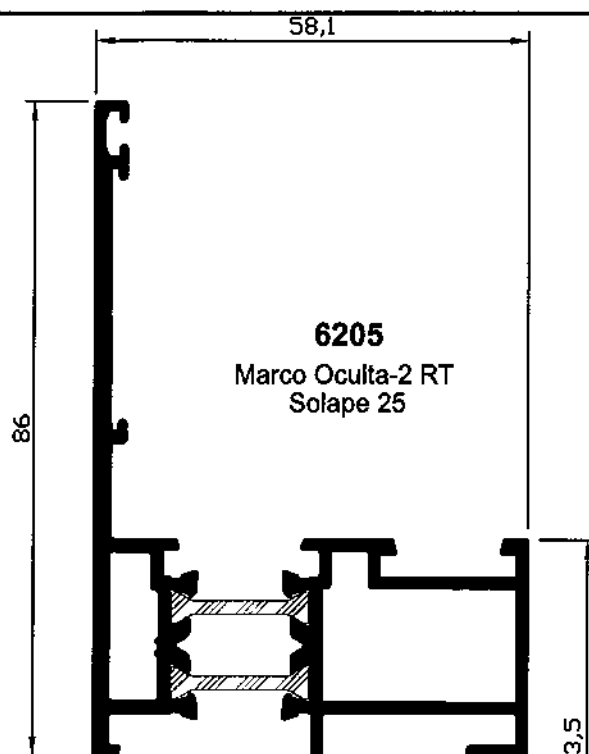
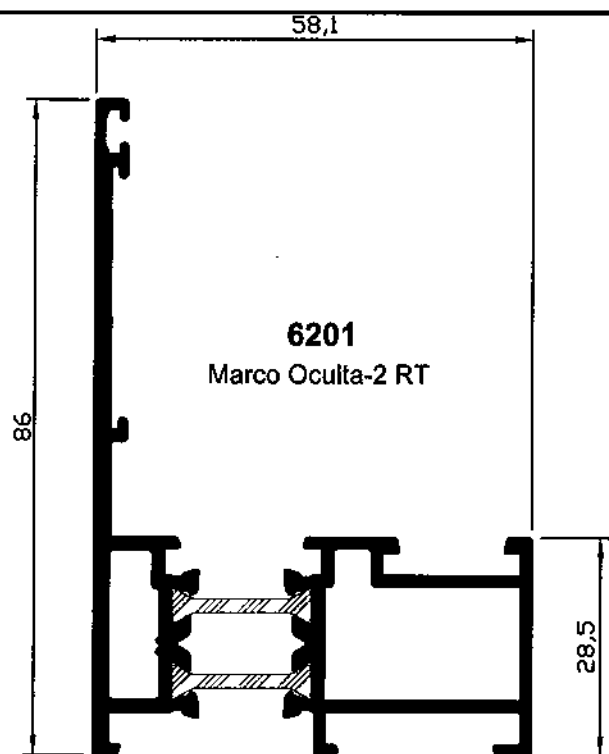











* NOTA: Perfiles solo para 1 hoja.



* NOTA: Perfiles 2 hojas.



REFERENCIA	MEDIDA JUNQUILLO	MEDIDA HUECO	
		PERFILES SERIE 6200RT	PERFIL 6202 
 361	29 mm	24,8	23,8
 362	24 mm	29,8	28,8
 363	19,5 mm	34,3	33,3
 364	14,5 mm	39,3	38,3
 365	10,5 mm	43,3	42,3
  371 372	26,4 mm	27,4	26,4
  373 374	22,4 mm	31,4	30,4
  375 376	18,4 mm	35,4	34,4
  377 378	14,4 mm	39,4	38,4

Guías
5 Medidas disponibles.

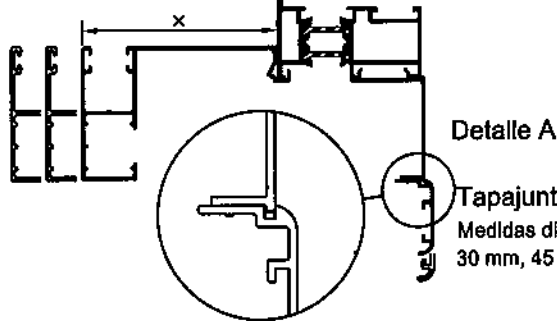

Detalle A

Tapajuntas
Medidas disponibles:
30 mm, 45 mm

Alargaderas
Medidas disponibles:
53 mm, 65 mm, 80 mm, 116 mm

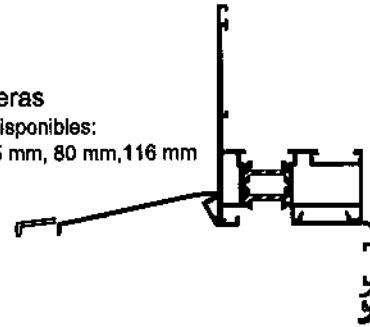

Tapajuntas Clipado
Medidas disponibles:
30 mm, 45 mm

Guías RT
Medidas totales:
120 mm, 130 mm, 140 mm
150 mm, 160 mm, 170 mm

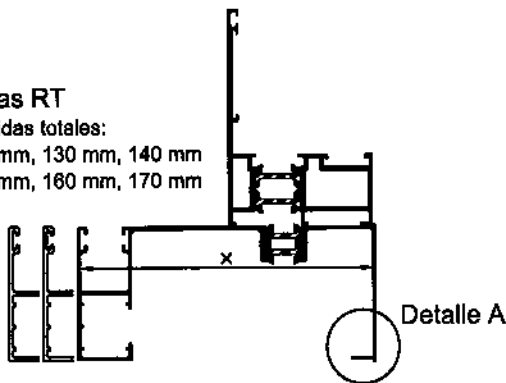

Detalle A

Tapajuntas Clipado
Medidas disponibles:
37 mm

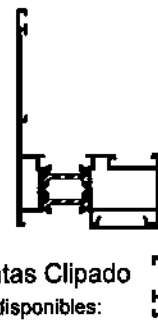

Tapajuntas de Grapa
Medidas disponibles:
50 mm, 70 mm, 85 mm

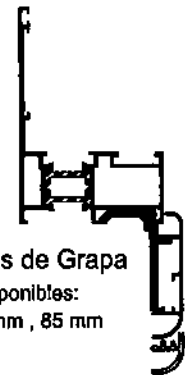

Guías
5 Medidas disponibles.

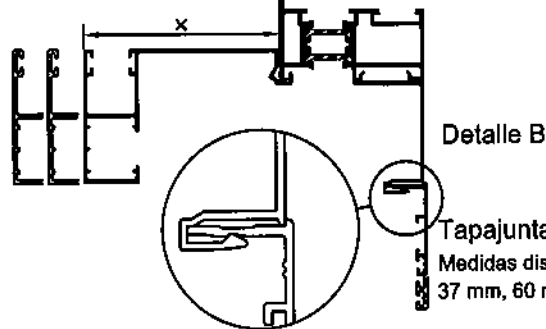

Detalle B

Tapajuntas
Medidas disponibles:
37 mm, 60 mm

Esquinero Regulable

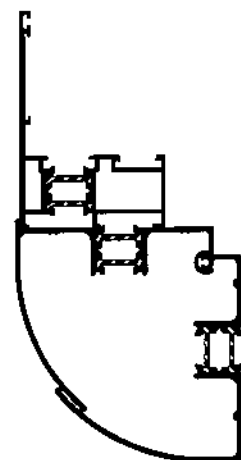

Guías Clip-R
Medidas totales:
120 mm, 130 mm, 140 mm
150 mm, 160 mm, 170 mm

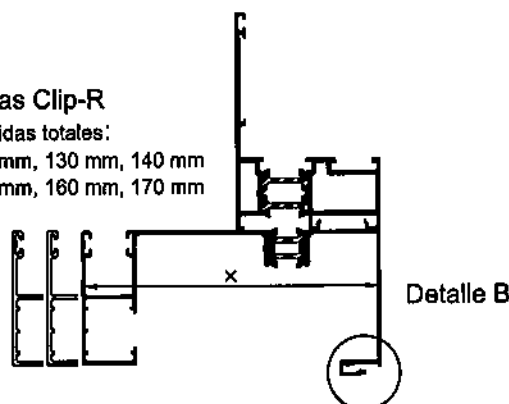

Detalle B

Para más información de perfiles complementarios, en el apartado **VARIOS** de este catálogo.



TABLA DE CORTES				
PERFIL	REF.	UDS.	MEDIDA	CORTE
Marco	6001	2	L	Horiz.
	6001	2	H	Vert.
Hoja	6002	2	L-45	Horiz.
	6002	2	H-45	Vert.
Tapajuntas	302	2	L+30	Horiz.
	302	2	H+30	Vert.

NOTA: LAS MEDIDAS SON ORIENTATIVAS, PUDIENDO VARIAR SEGÚN EL TIPO DE HERRAJE QUE SE UTILICE
ROGAMOS VERIFIQUEN LAS MEDIDAS ANTES DE CORTAR EL MATERIAL EN SERIE.



Sección A

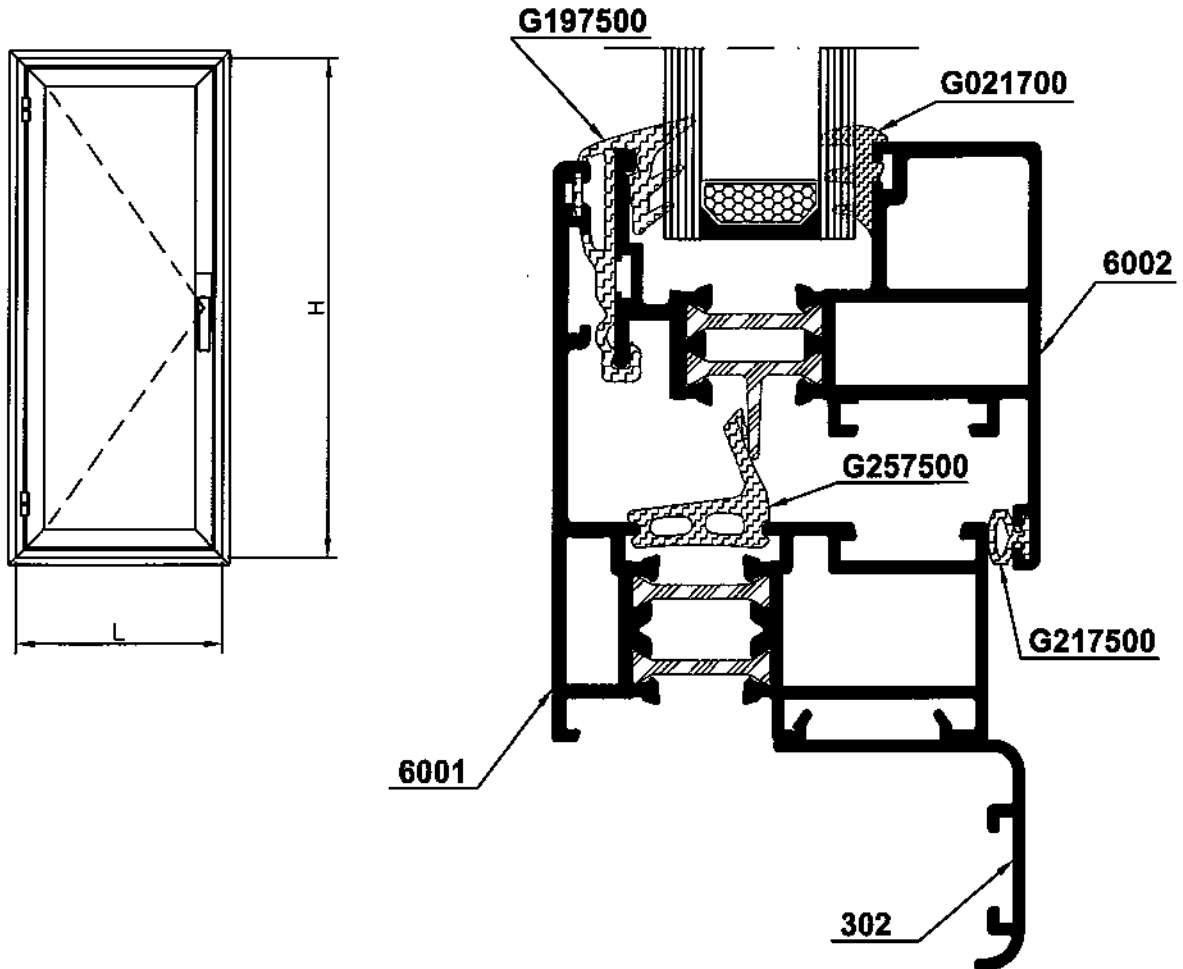
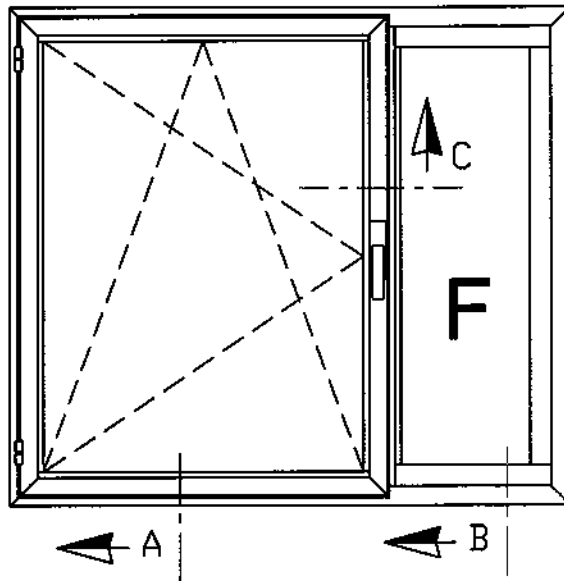
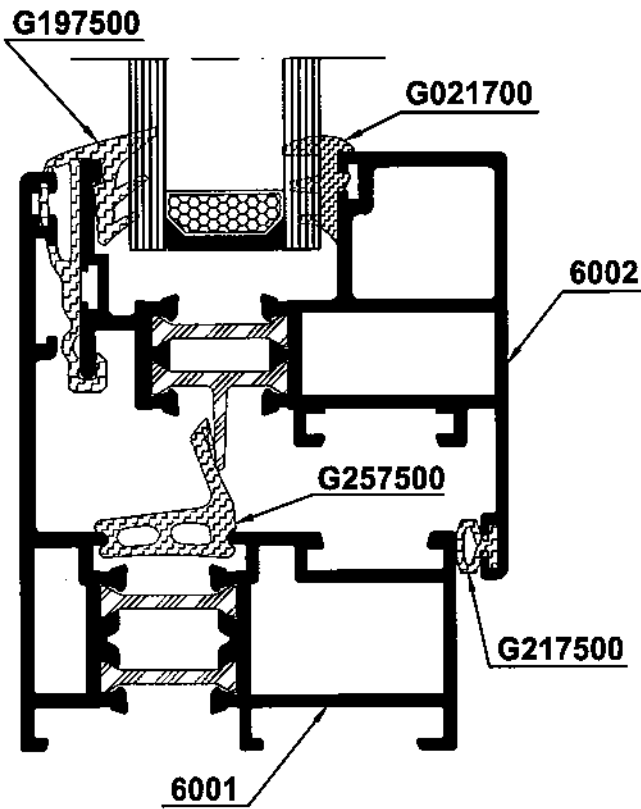

Sección B

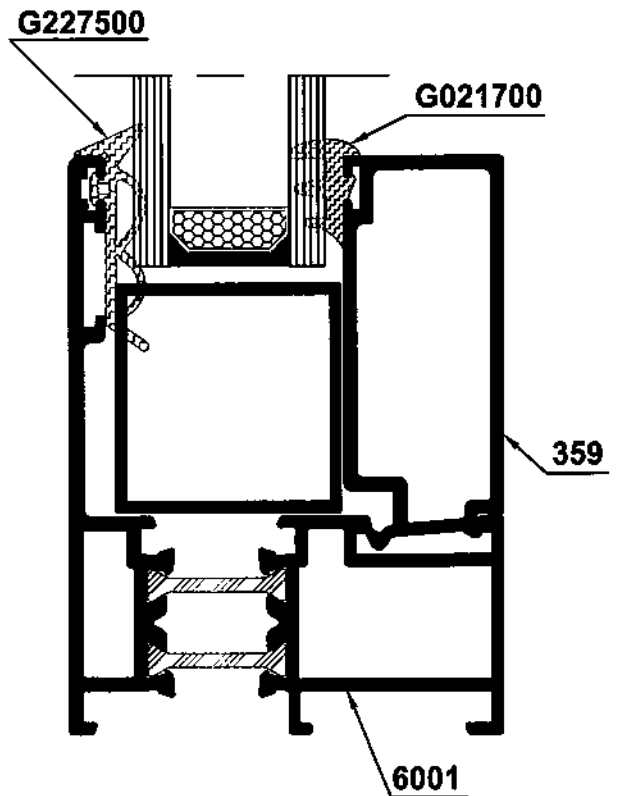

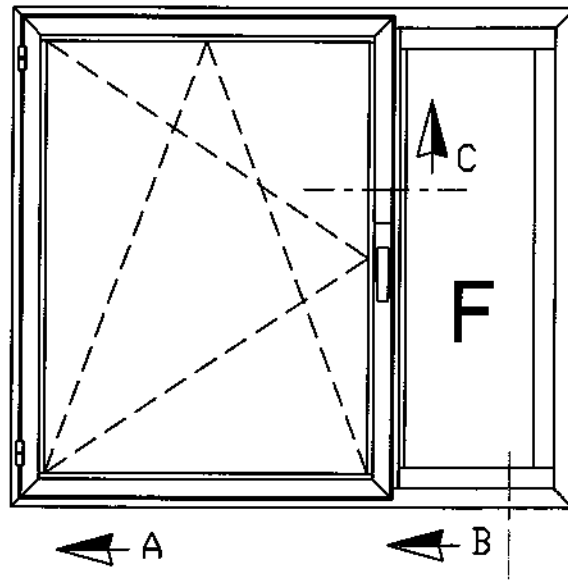

Sección C

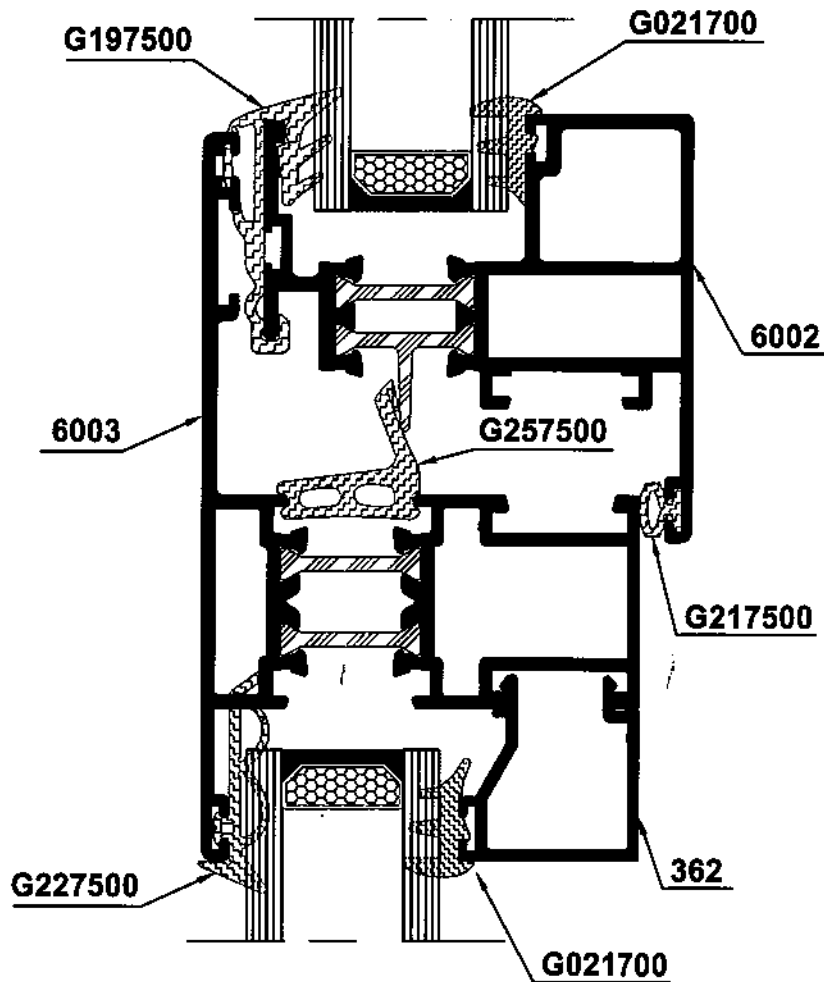

VENTANA 2 HOJAS



TABLA DE CORTES

	ANCHURA DE HOJA	ALTURA DE HOJA	ALTURA PERFIL INVERSOR
VENTANA UNA HOJA	L-45	H-45	H-106
VENTANA DOS HOJAS	(L-50)/2		



NOTA: LAS MEDIDAS SON ORIENTATIVAS, PUDIENDO VARIAR SEGÚN EL TIPO DE HERRAJE QUE SE UTILICE
ROGAMOS VERIFIQUEN LAS MEDIDAS ANTES DE CORTAR EL MATERIAL EN SERIE.

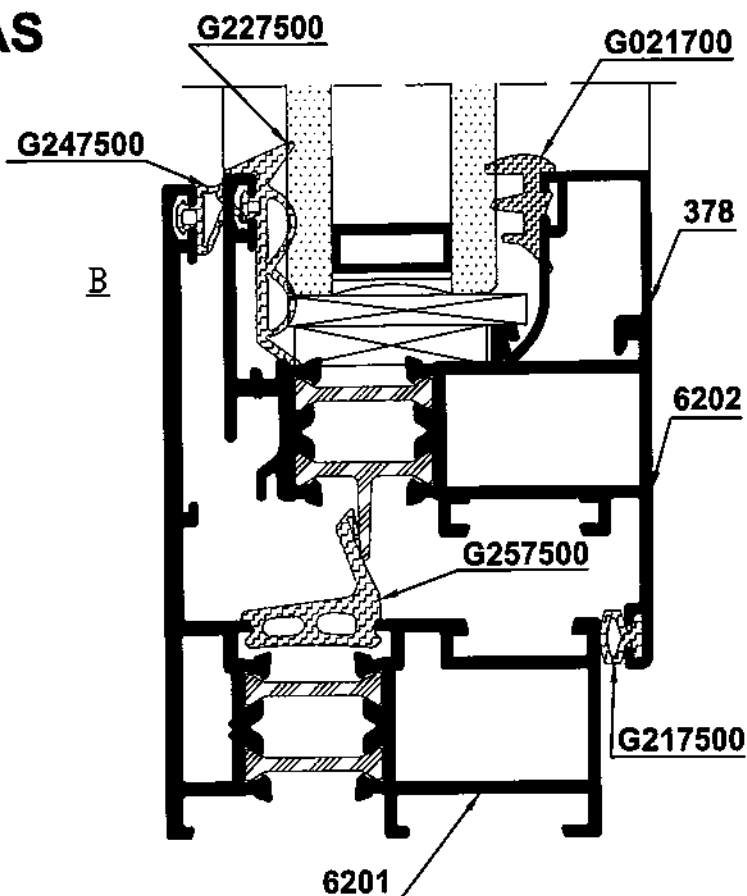
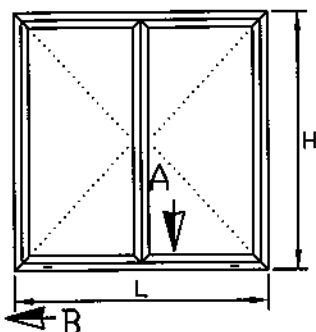
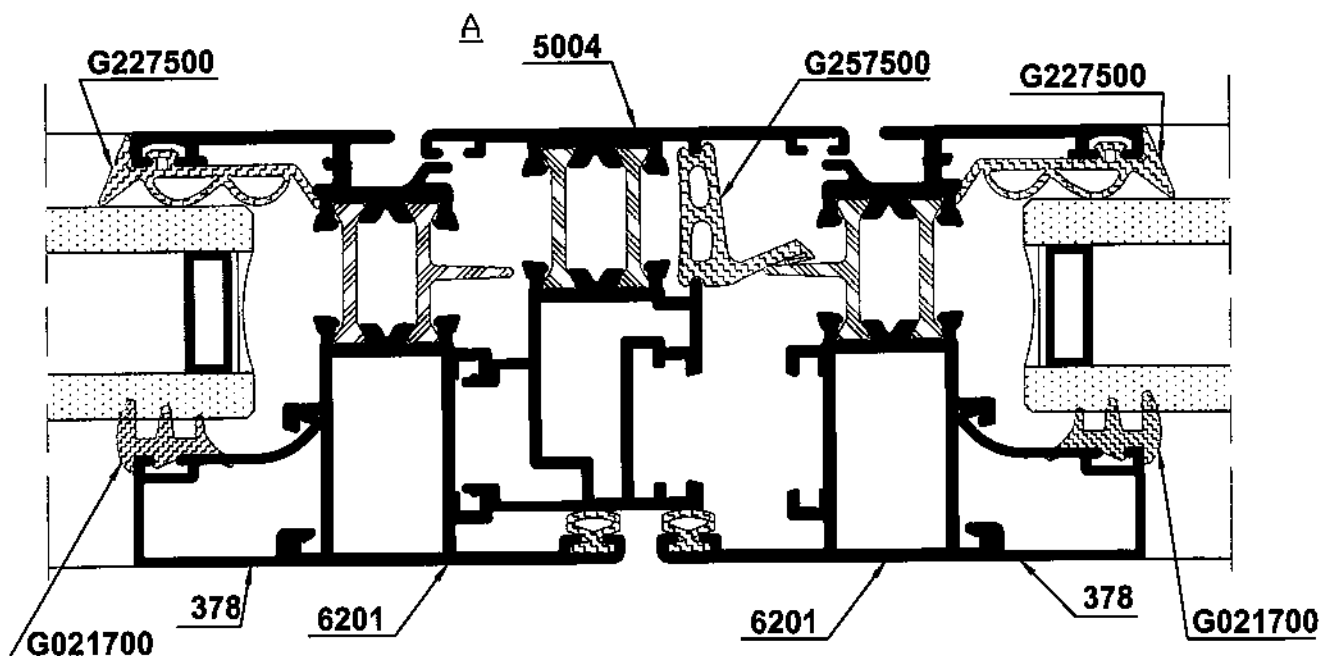

CR1574xx

Cremona normal primo



CR1674xx

Cremona O/B primo



CR1774xx

Cremona unica apertura exterior



CR1874xx

Cremona O/B primo key



B3074xx Dch
B3174xx Izq

Bisagra flash premontada



K437400

Kit 1 hoja batiente



K4474xx

Kit O/B futura 3D



V807400

Compas O/B futura
550-1700



V817400

Compas O/B futura
390-550

V867400



Encuentro simple ZAMAK
GIAP y tercer punto

V887400



Encuentro doble ZAMAK GIAP

V1037400



Encuentro regulable simple

E540200

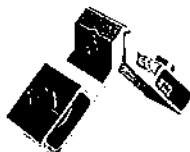

Escuadra muelle S-RT
Ventana

E520200

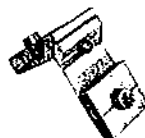

Escuadra muelle hoja 6002

E342700



Escuadra alineación M-H-T
PVC

E580200



Escuadra alineación corta
tras burbuja

E590200



Escuadra alineación marco
carril goma

E672200



Escuadra alineación larga
tras burbuja

E680800



Escuadra alineación marco
6200RT

E630900



Escuadra alineación ext hoja
6202

V0127xx



Salida aguas

IGR505000



Grapa tapajuntas

TP012700



Tapa inversora S-RT blanda
(Juego)

V2863xx



Golpete grande C.E.

V1047400



Compas retenedor abatible
H=250-500

V1057400



Compas retenedor abatible
H=350-2000



Troquel series abisagradas
muelle

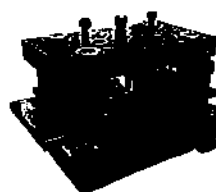

Troquel series abisagradas
bloqueo



Juego de fresas 6000RT



Juego de fresas 6200RT



G257500

Goma central S-RT EPDM



G021700

Goma cuña pequeña E4



G031700

Goma cuña grande E6



G091700

Goma acristalar perfil EPDM E4



G140300

Goma acristalar dura
60JBT23 E4



G197500

Goma hoja oculto
S-6000 RT



G217500

Goma burbuja EPDM doble
dureza



G227500

Goma acristalar perfil EPDM
acustica E3



G237500

Goma acristalar perfil EPDM
acustica E3



G247500

Goma ext. marco EPDM
S-6200 RT

Leyenda de Colores de Accesorios:

01 - Blanco 02 - Negro
03 - Oro 06 - Plata

Ejemplo:
Referencia base: B3074xx
Referencia blanco: B307401

Consultar colores disponibles en tarifa.