

VENTANA ABISAGRADA SERIE 4045	DIMENSION	RESULTADO			CERTIFICADO
		AIRE	AGUA	VIENTO	
	1200 x 1200 Alumarte	CLASE	CLASE	CLASE	ARCO TECNOS
		4	9 A	C 5	

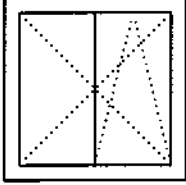

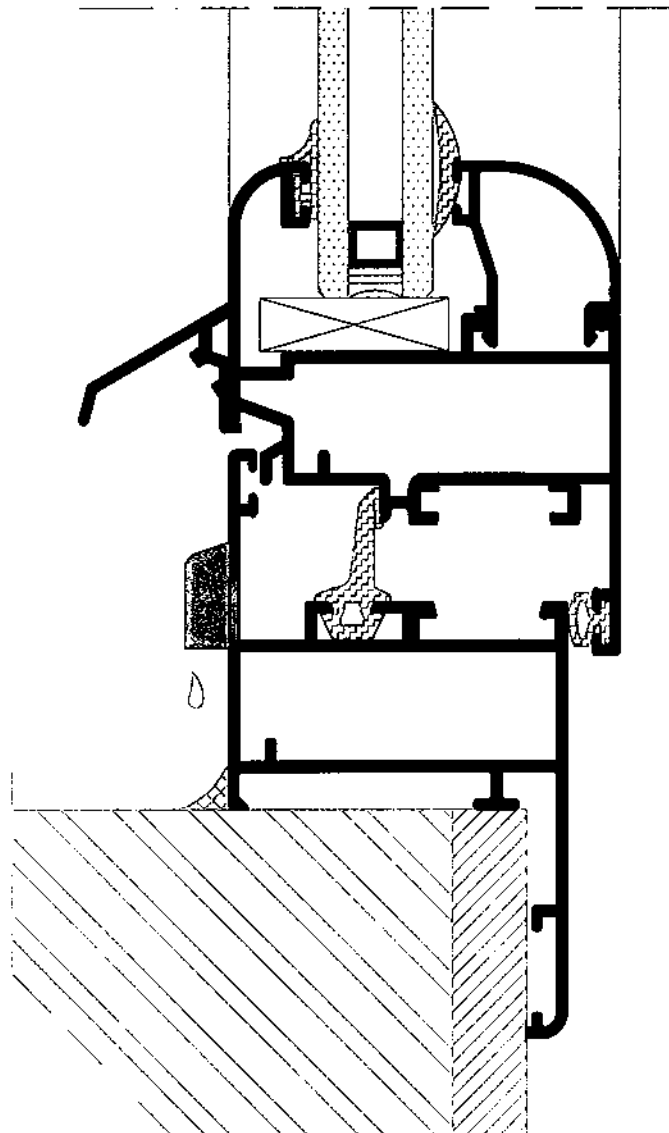

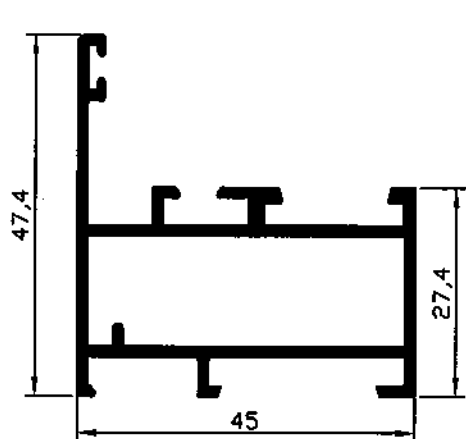

**4501**  
Marco

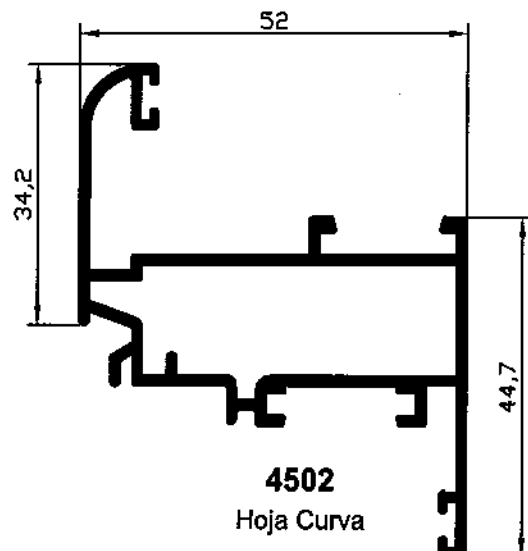

**4502**  
Hoja Curva

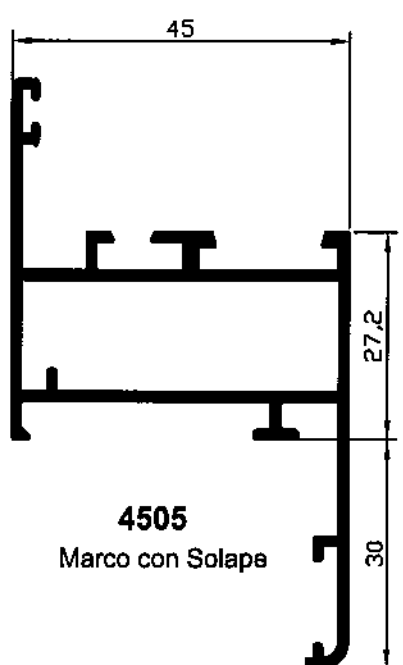

**4505**  
Marco con Solapa

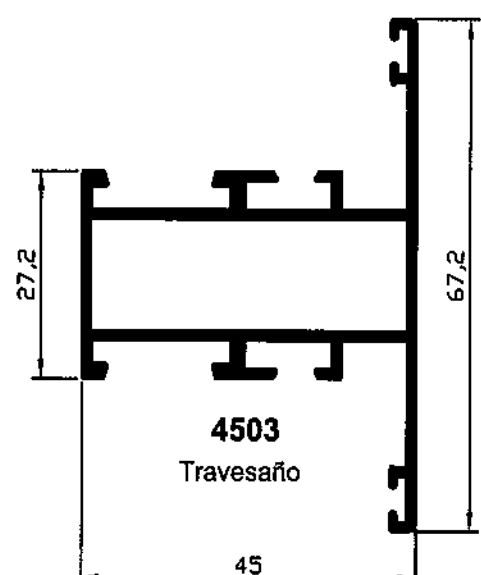

**4503**  
Travesaño

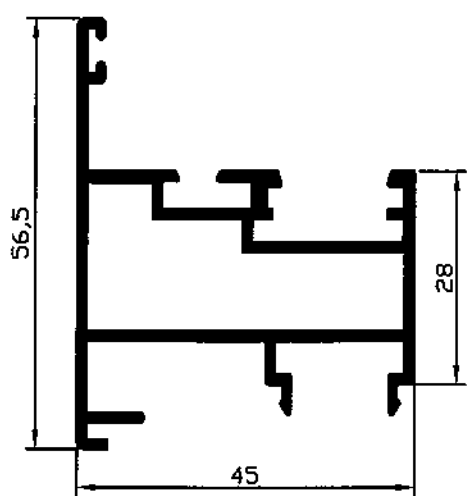

**4504**  
Perfil inversor

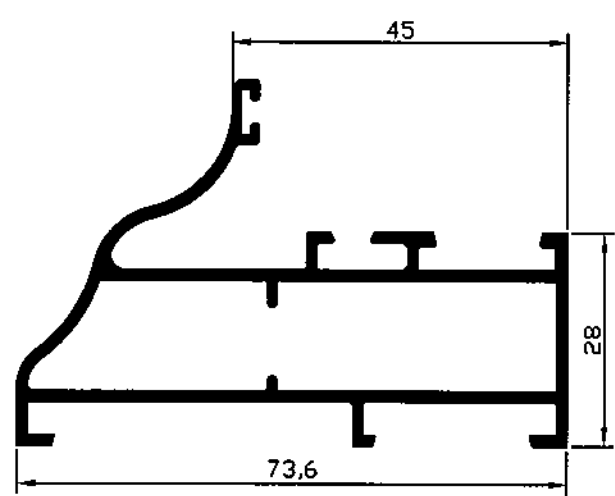

**711**  
Marco

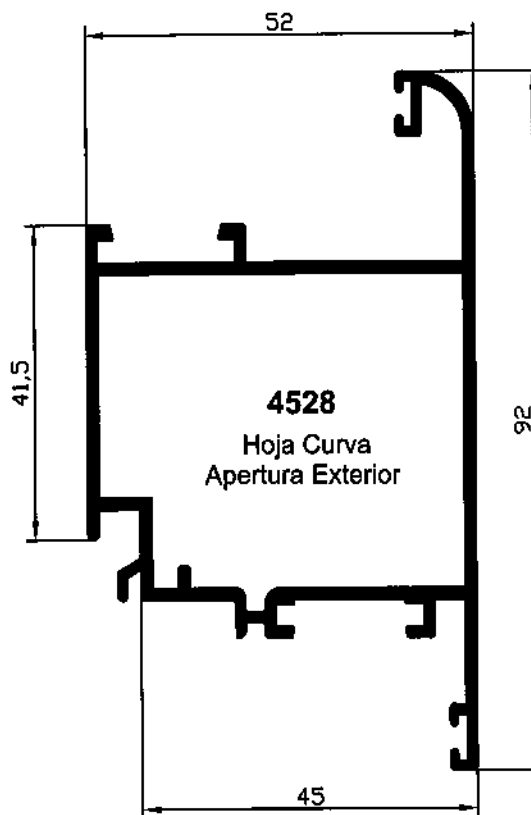
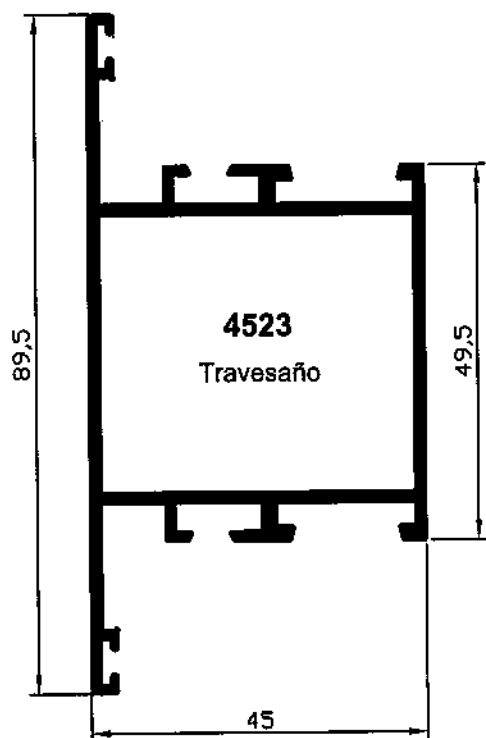
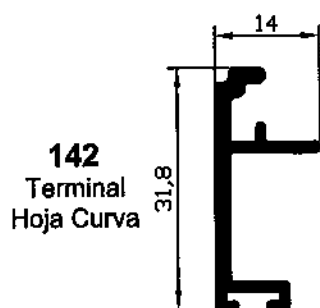
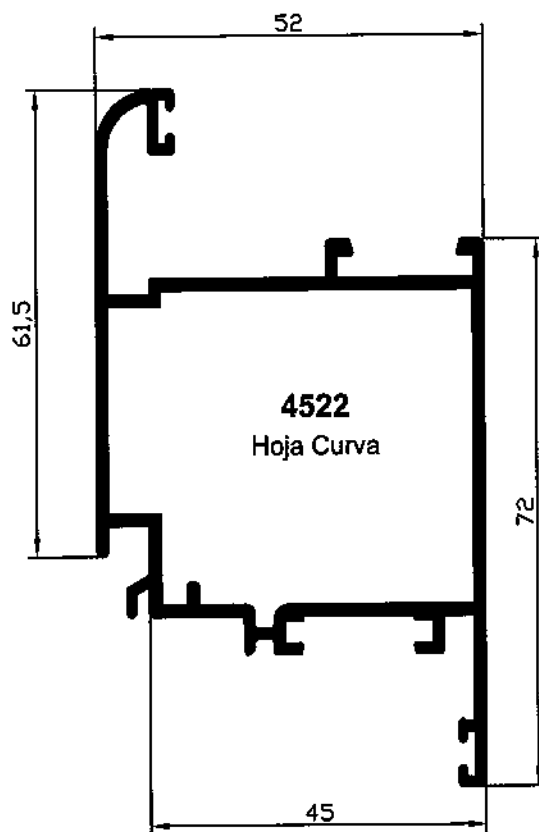
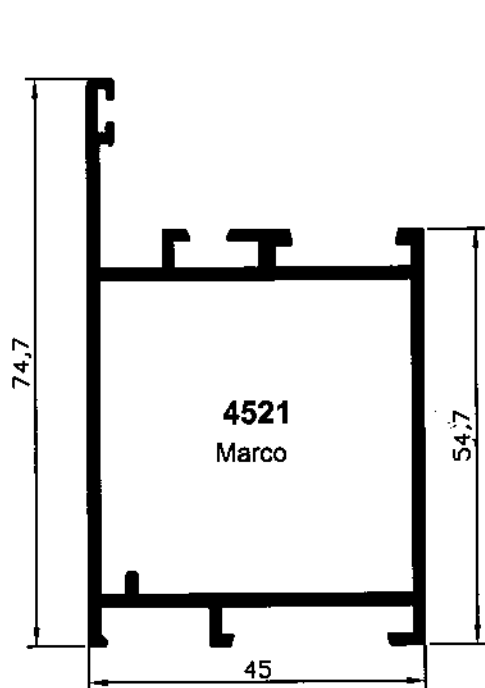

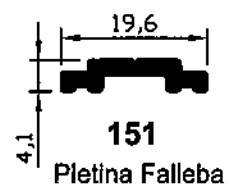
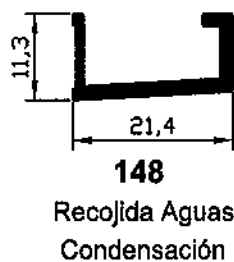
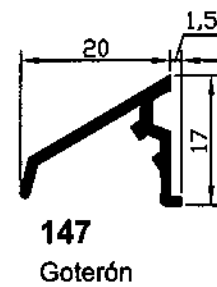
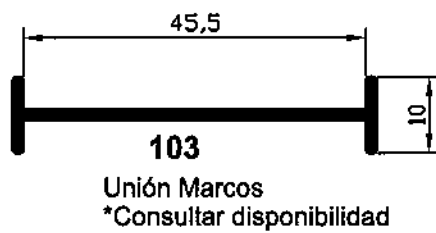
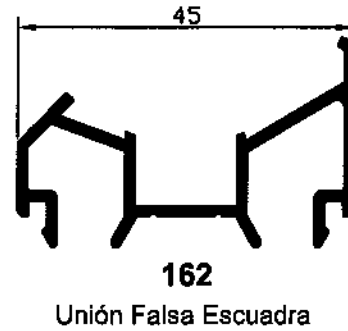
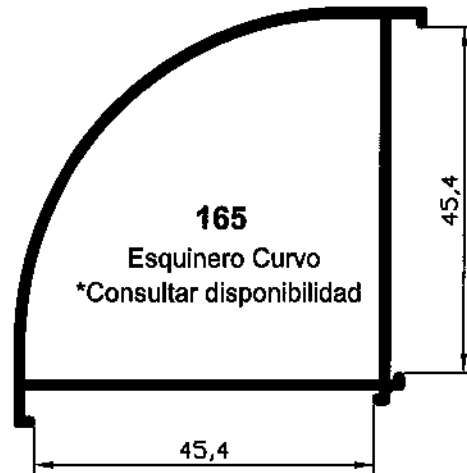
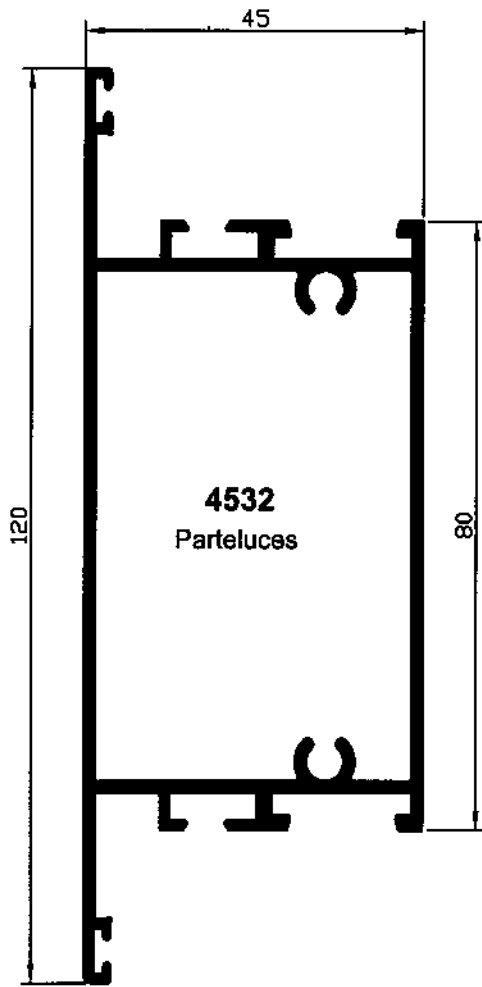

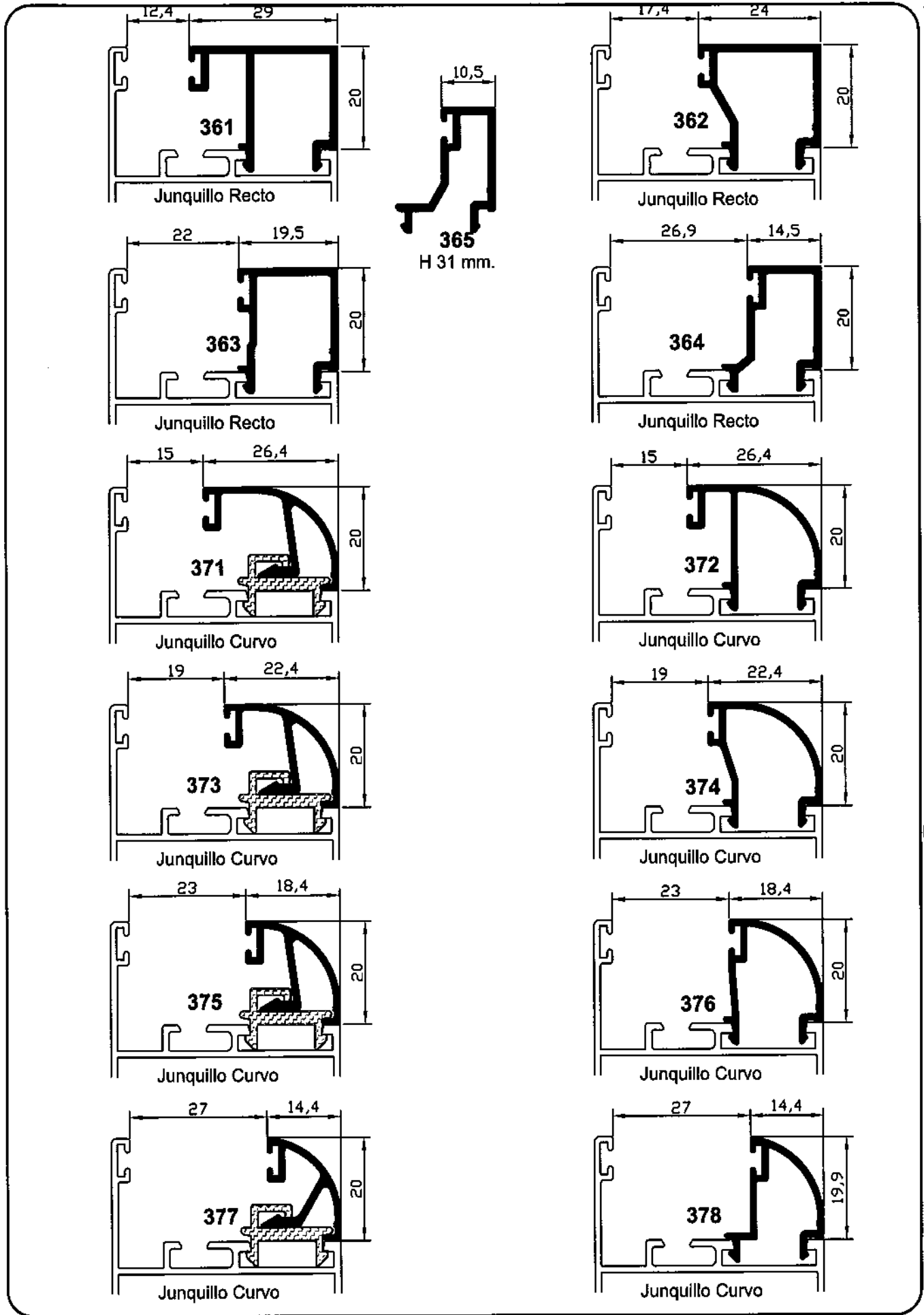

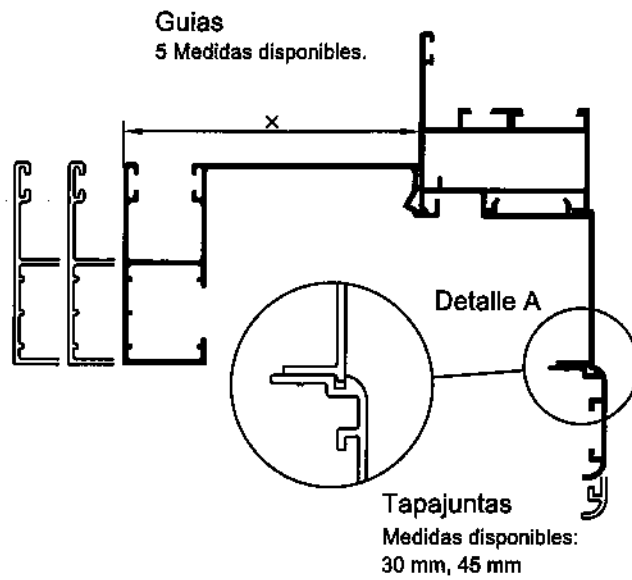

**Alargaderas**  
Medidas disponibles:  
53 mm, 65 mm, 80 mm, 116 mm

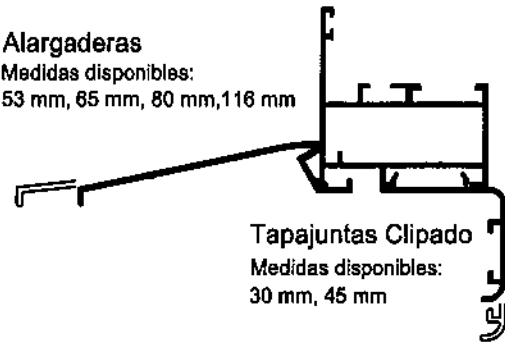

**Tapajuntas Clipado**  
Medidas disponibles:  
30 mm, 45 mm



**Tapajuntas Clipado**  
Medidas disponibles:  
37 mm

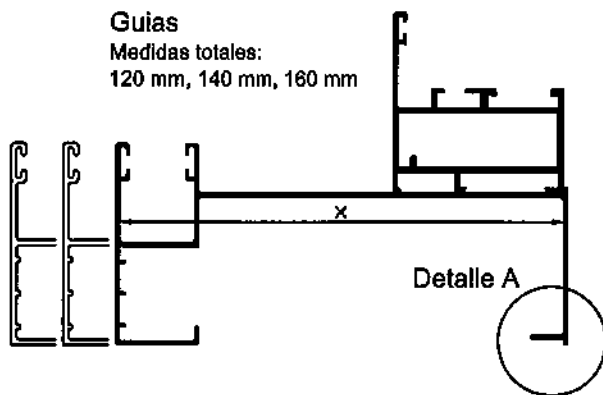

**Tapajuntas de Grapa**  
Medidas disponibles:  
50 mm, 70 mm, 85 mm

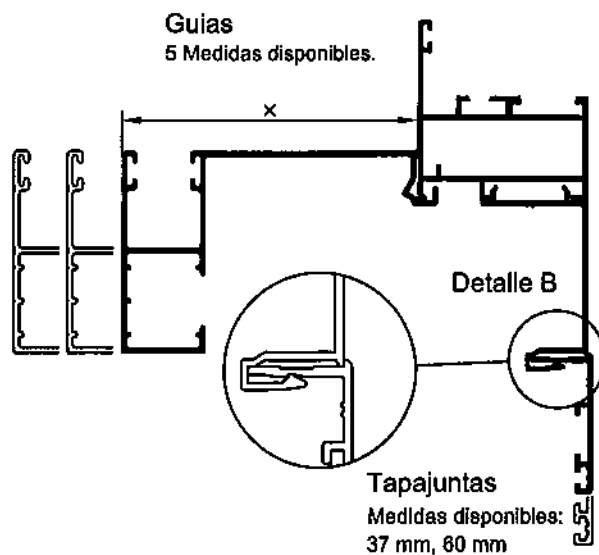

**Esquinero Fijo**

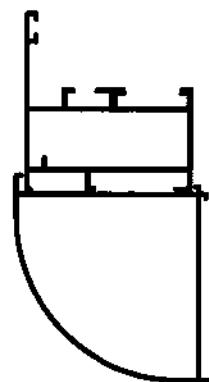

**Esquinero Regulable**

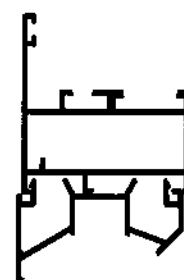

Para más información de perfiles complementarios, en el apartado **VARIOS** de este catálogo.





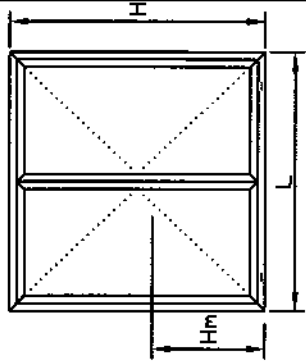

**TABLA DE CORTES**

	FALLEBA SUPERIOR	FALLEBA INFERIOR	VENTANA UNA HOJA	VENTANA DOS HOJAS	ANCHURA DE HOJA	ALTURA DE HOJA	ALTURA PERFIL INVERSOR
ACCESORIOS ZAMAC	(H-42)-Hm-123	Hm-123	L-42			H-42	H-103
ACCESORIOS NYLON	(H-42)-Hm-123	Hm-123	(L-46,5)/2				
ACCESORIOS ECONOMICOS	(H-42)-Hm-126	Hm-130					

NOTA: LAS MEDIDAS SON ORIENTATIVAS, PUDIENDO VARIAR SEGUN EL TIPO DE HERRAJE QUE SE UTILICE  
ROGAMOS VERIFIQUEN LAS MEDIDAS ANTES DE CORTAR EL MATERIAL EN SERIE.

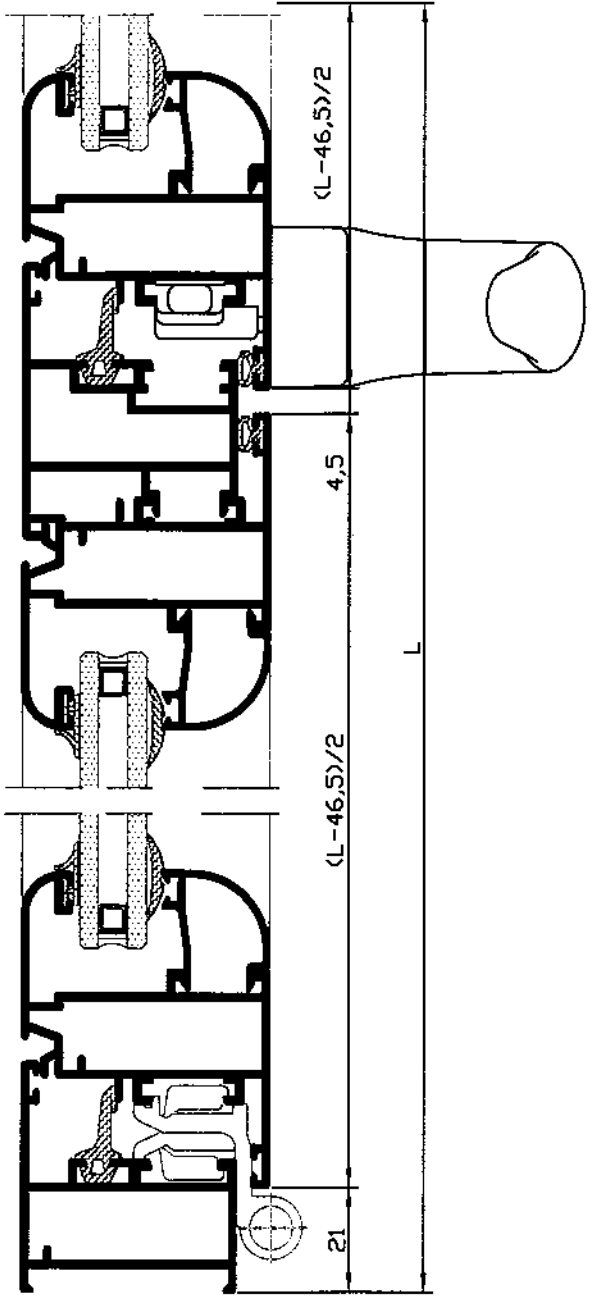
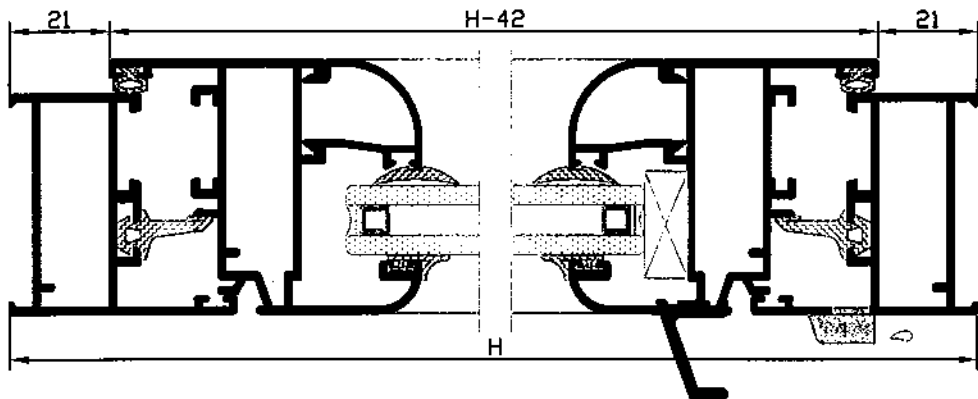

## VENTANA 1 HOJA

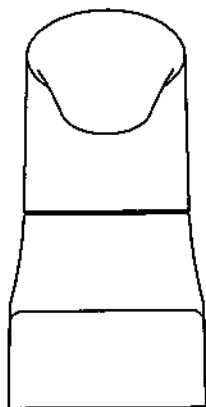
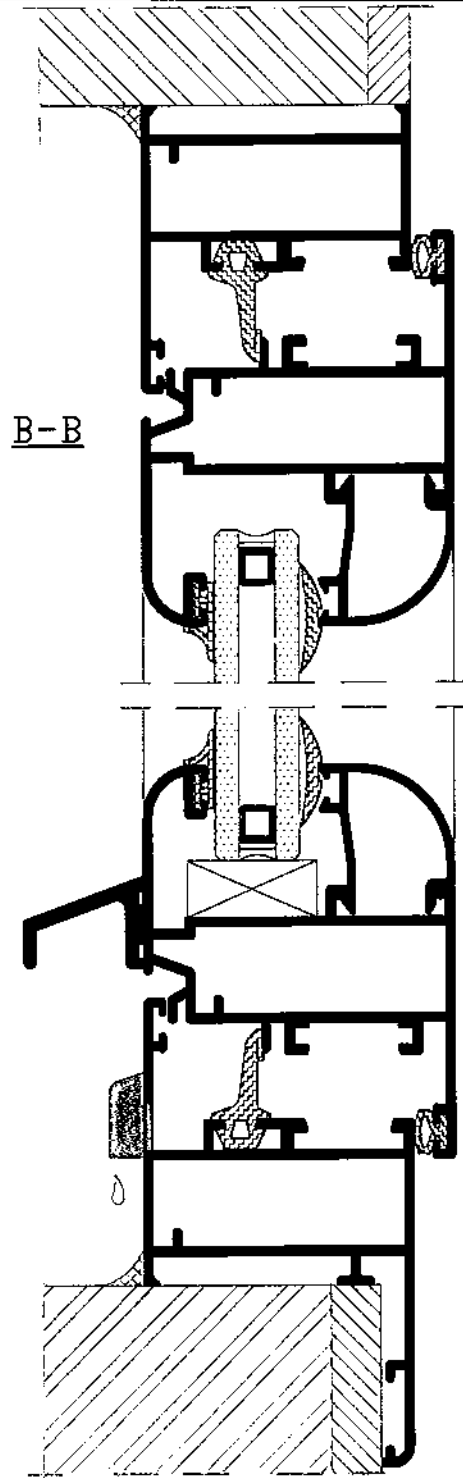
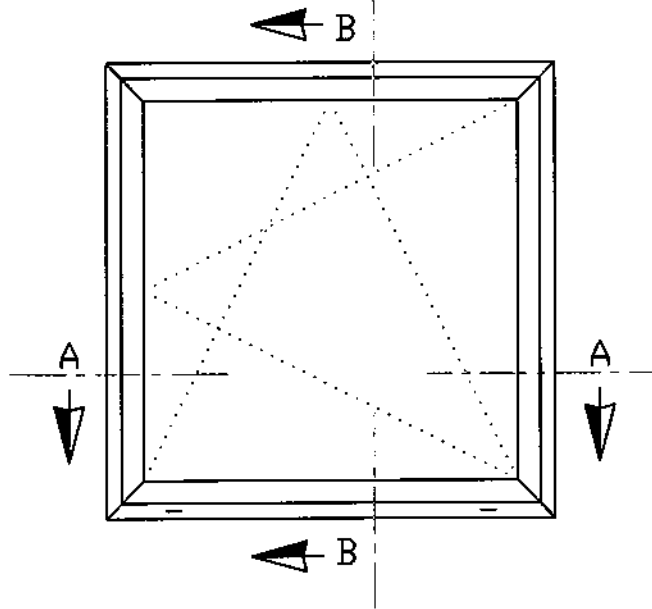

A-A

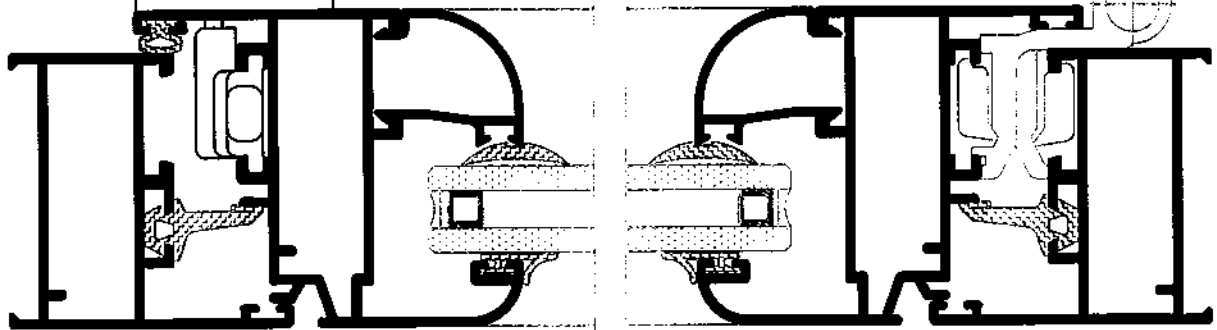

## VENTANA 2 HOJAS

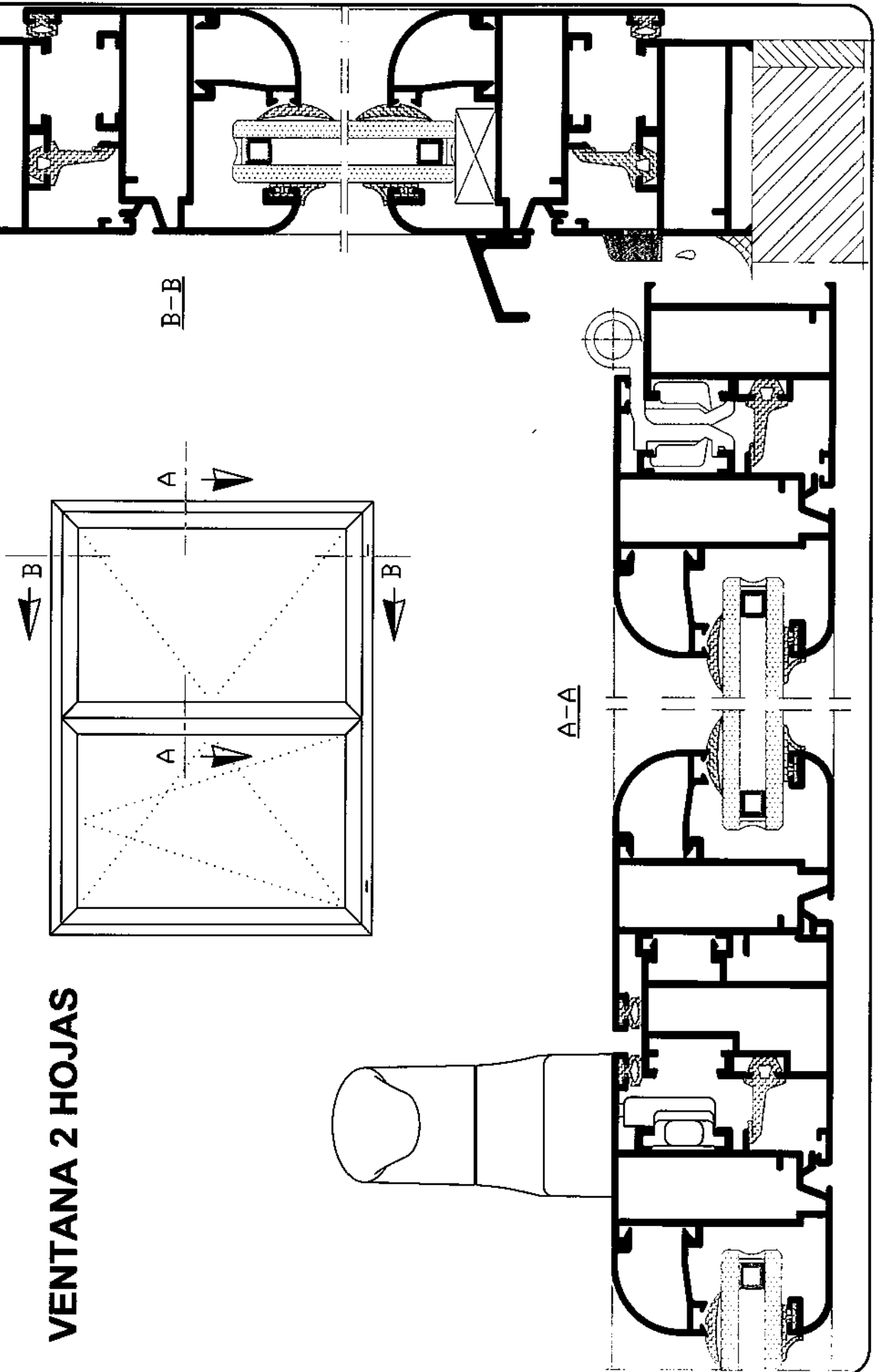

## VENTANA TOLVA

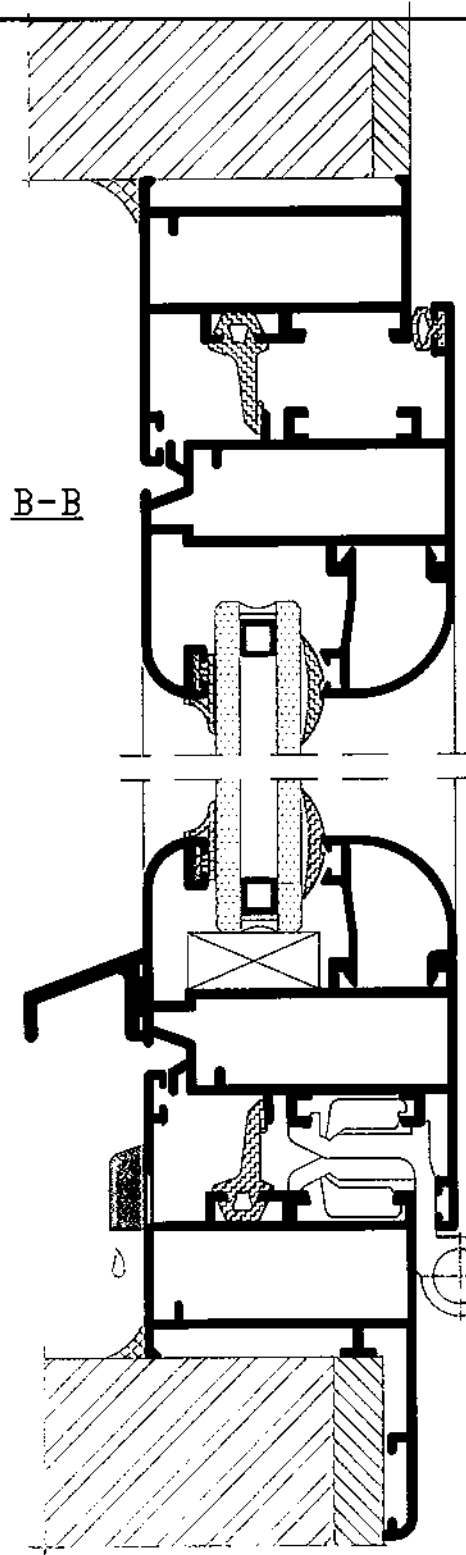
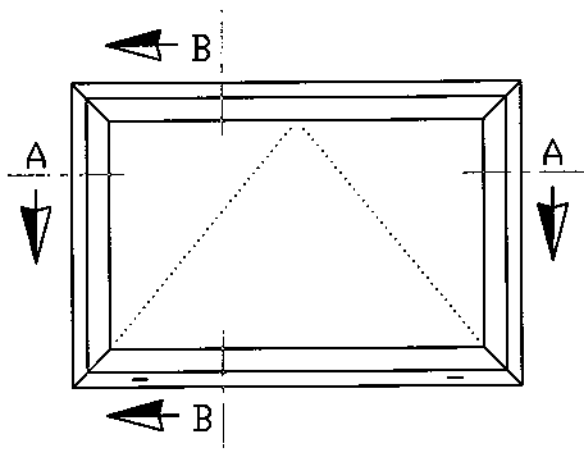

A-A

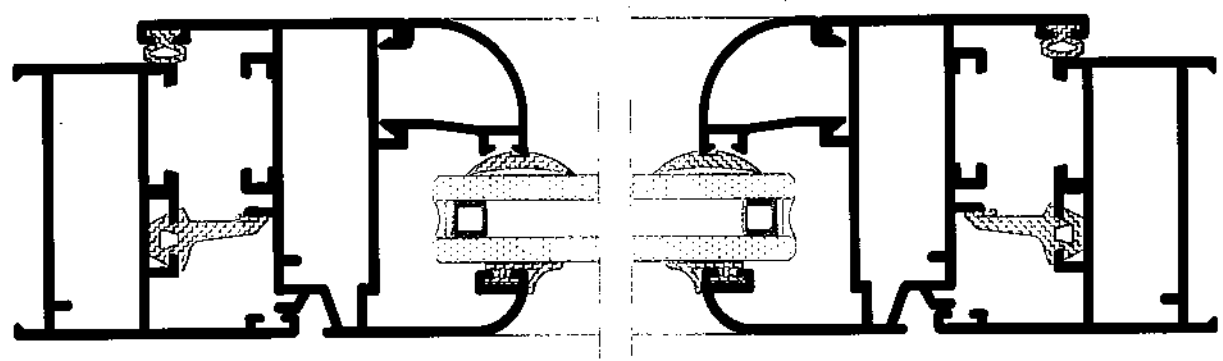

## PUERTA 1 HOJA

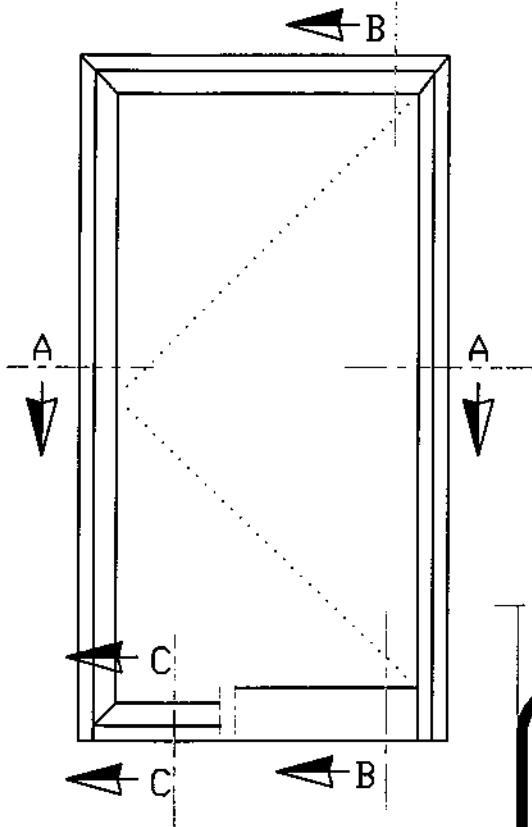

B-B

C-C

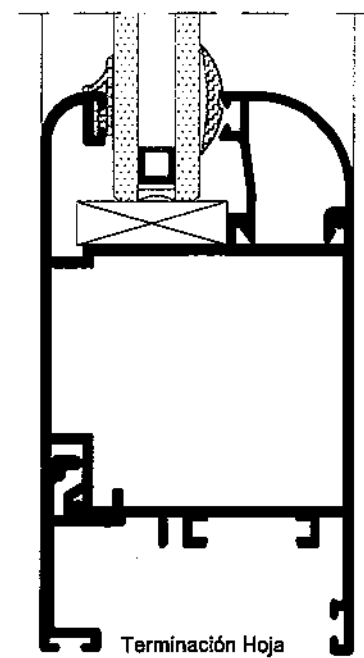

Terminación Hoja

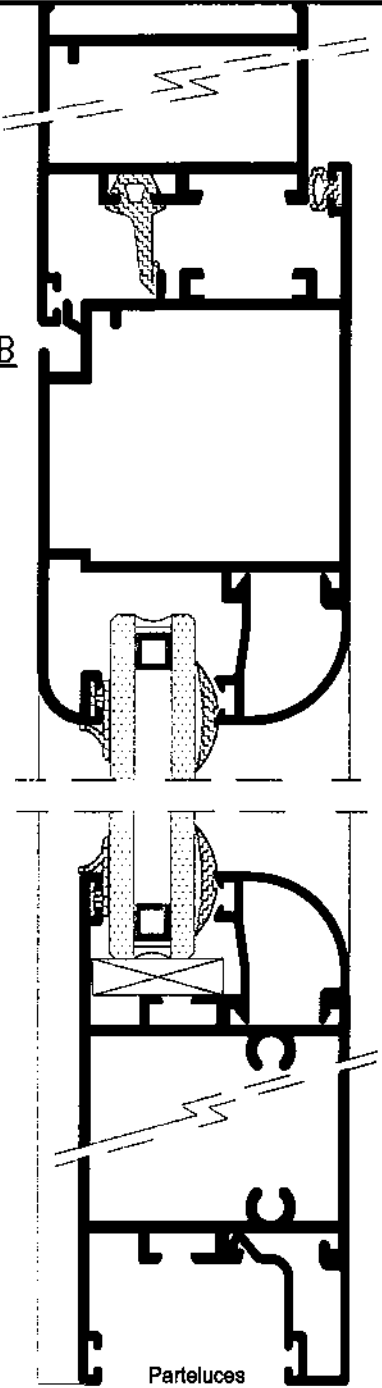

Parteluces

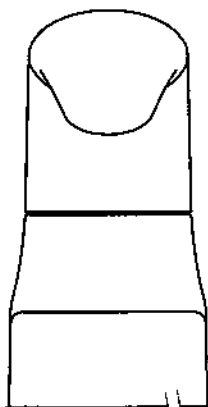

A-A

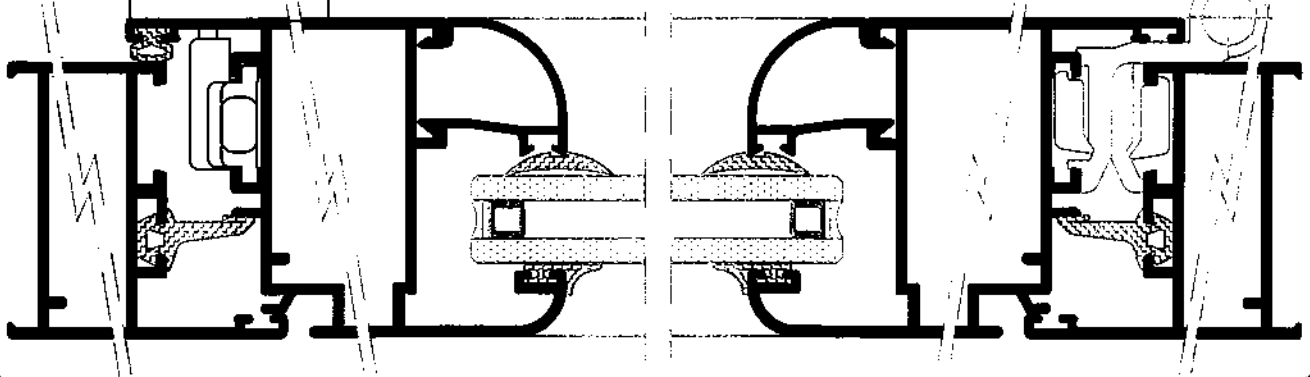

## BALCONERA 1 HOJA

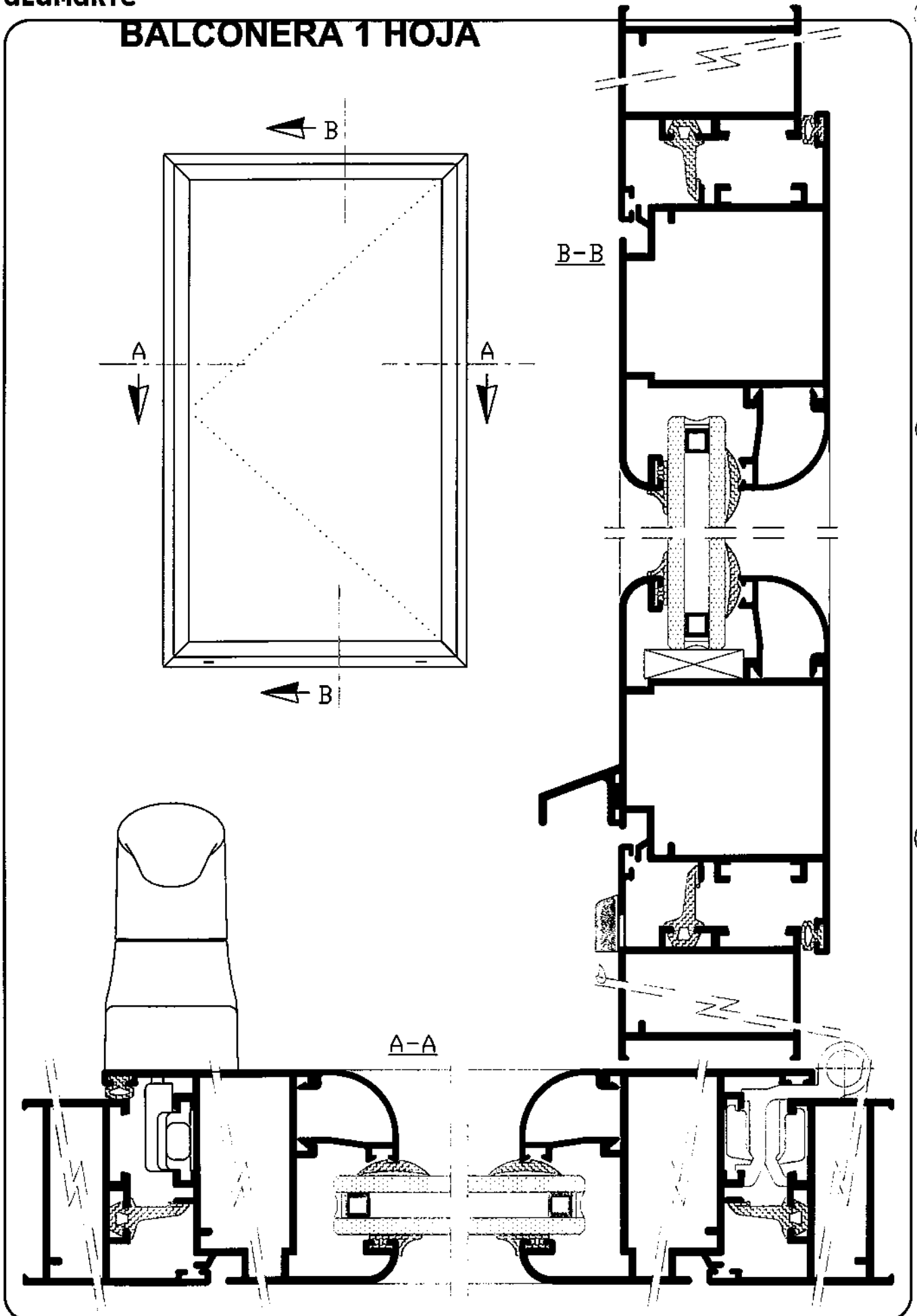

## PUERTA VAIVEN

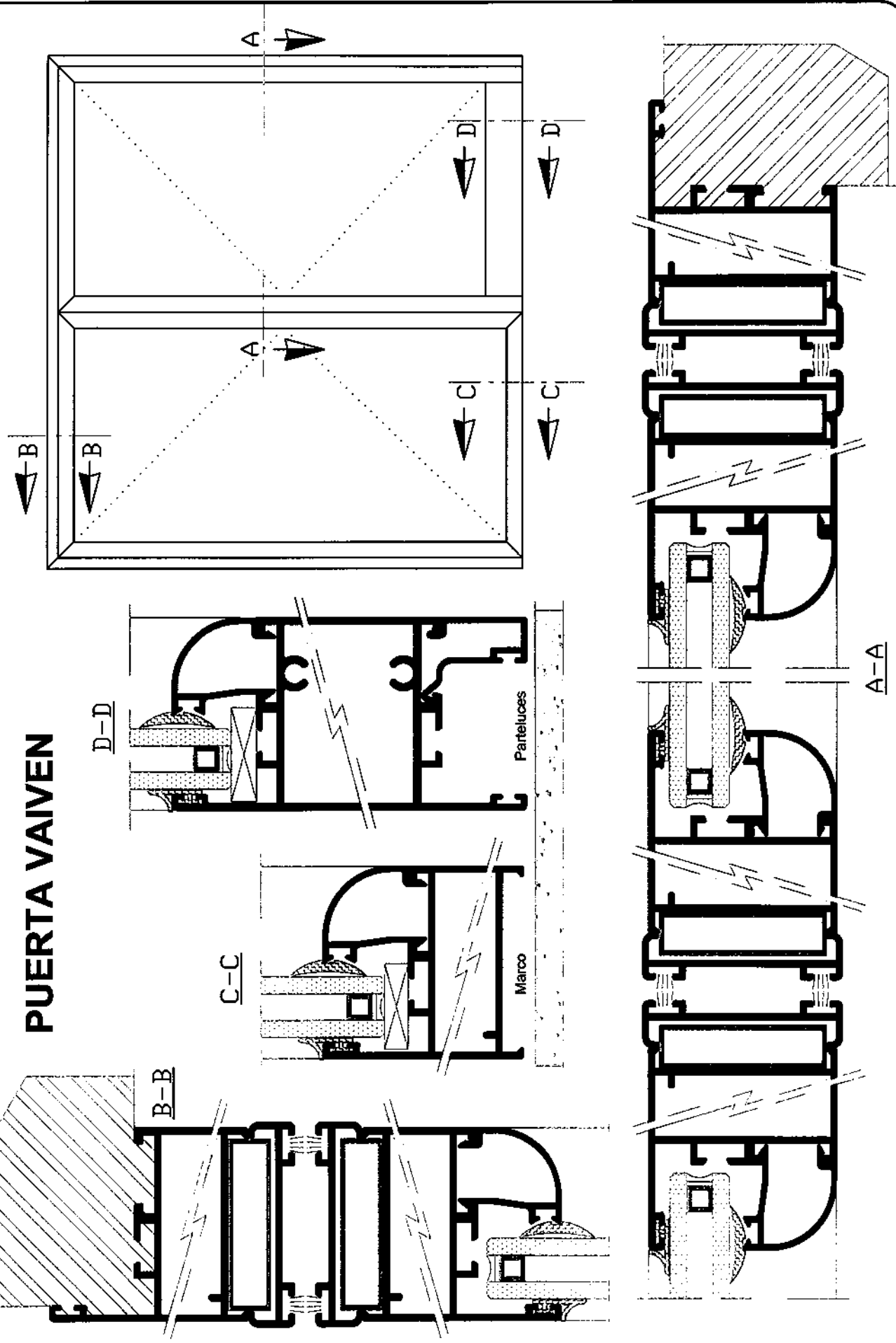

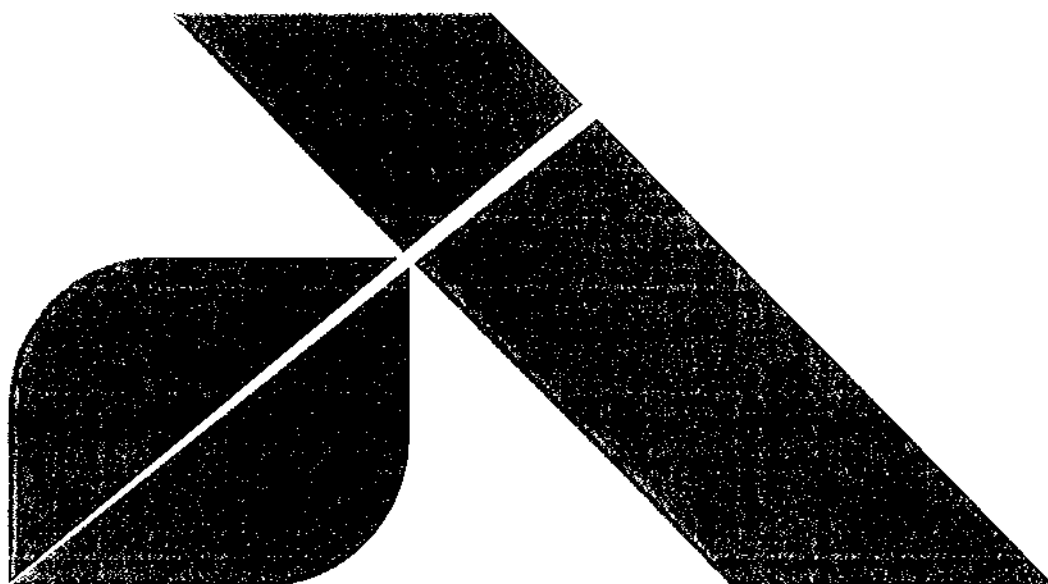





CR1574xx

Cremona normal primo



CR1674xx

Cremona O/B primo



CR1774xx

Cremona unica apertura exterior



CR1874xx

Cremona O/B primo key



V8974xx

Manilla flora (pareja)



B2728xx

Bisagra puerta C.E.



B3074xx Dch  
B3174xx Izq

Bisagra flash premontada



B3274xx

Bisagra domina HP3 alas

K437400



Kit 1 hoja batiente

K467400



Kit 2 hojas batiente

K4474xx



Kit 0/B futura 3D

B427400



Kit 0/B 2ª hoja futura 3D

V287400



Posador a suelo GIAP futura

V837400



Posador 0/B 2ª hoja GIAP

V857400



Posador 2ª hoja  
bidireccional a leva

V807400



Compos 0/B futura  
550-1700

V817400



Compos 0/B futura  
390-550

V867400



Encuentro simple ZAMAK  
GIAP y tercer punto

V887400



Encuentro doble ZAMAK GIAP

V1037400



Encuentro regulable simple



**E010200**

Escuadra bloqueo 37x16  
Ventana



**E120200**

Escuadra bloqueo 37x40  
Puerta



**E530200**

Escuadra muelle S-4045  
Ventana



**E710200**

Escuadra muelle S-4045  
Puerta



**E342700**

Escuadra alineación M-H-T  
PVC



**E352700**

Escuadra alineación hojas  
S-4000 / S-4045 PVC



**E580200**

Escuadra alineación corta  
tras burbuja



**E590200**

Escuadra alineación marco  
carril goma



**E672200**

Escuadra alineación larga  
tras burbuja

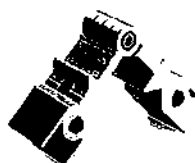

**E130700**

Escuadra graduable  
Ventana



**E230200**

Union travesaño puerta  
35mm



**G250200**

Union travesaño ventana  
14mm



**TP046500**

Tapa inversora S-4045  
(Juego)



**TP086600**

Tapa recogida condensación  
(Juego)



**V044600**

Grapa junquillos series  
abisagrada



**IGR505000**

Grapa tapajuntas



**V1047400**

Compas retenedor abatible  
H=250-500



**V1057400**

Compas retenedor abatible  
H=350-2000



**V0127xx**

Salida aguas



**V2863xx**

Golpete grande C.E.



G061700

Goma central S-4045 EPDM



G021700

Goma cuña pequeño E4



G031700

Goma cuña grande E6



G091700

Goma acristalar perfil EPDM E4



G217500

Goma burbuja EPDM doble dureza



G227500

Goma acristalar perfil EPDM doble acustica E3



G237500

Goma acristalar perfil EPDM acustica E3



Troquel series abisagradas muelle

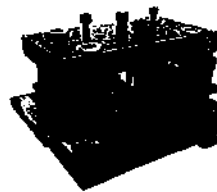

Troquel series abisagradas bloqueo



Juego de fresas

### Leyenda de Colores de Accesorios:

01 - Blanco      02 - Negro  
03 - Oro         06 - Plata

Ejemplo:  
Referencia base: B3074xx  
Referencia blanco: B307401

Consultar colores disponibles en tarifa.

**SERIE S-4045**

CERRADERO REGULABLE METALICO		CERRADERO EN NYLON	
A-B-C	D E-F	A-B-C	D E-F
06463.08	06463.08 (17)	06465.02	

(17) Inserto para rodillo 06141.71

CILINDRO EUROPERFIL REF. 08310.12.0.12

ENTRADA = 35 mm.

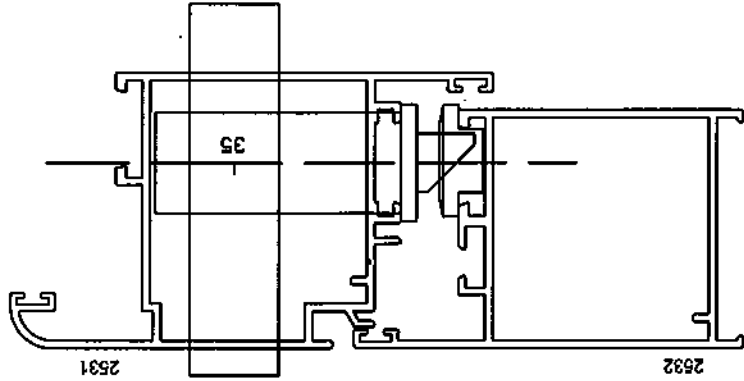

**CERRADURA VERTICAL DE SEGURIDAD**

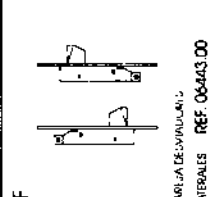
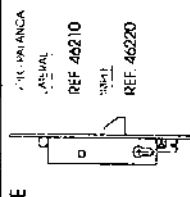
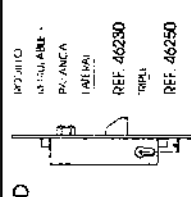
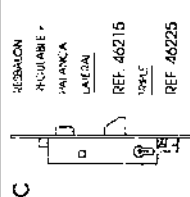
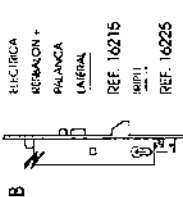
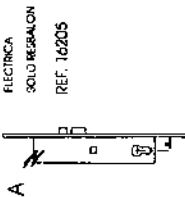

**SERIE S-4045 (Apertura exterior)**

CERRADERO REGULABLE METALICO		CERRADERO EN NYLON	
A-B-C	D E-F	A-B-C	D E-F
06463.08	06463.08 (17)	06465.02	

(17) Inserto para rodillo 06141.71

CILINDRO EUROPERFIL REF. 08310.12.0.12

ENTRADA = 35 mm.

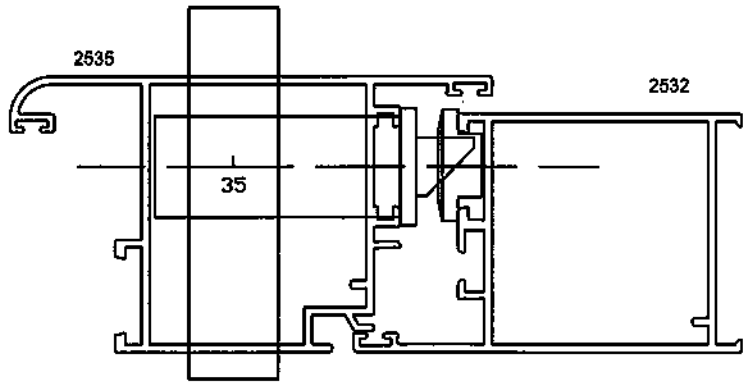

**CERRADURA VERTICAL DE SEGURIDAD**

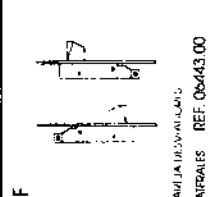
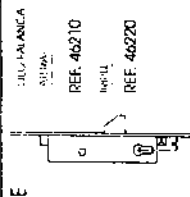
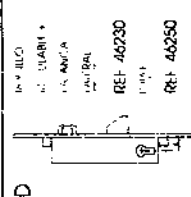
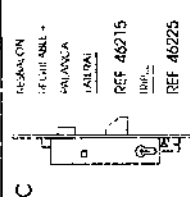
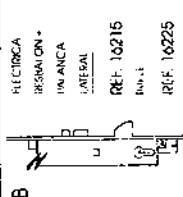
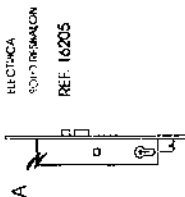

**SERIE S-4045**

CERRADEROS REGULABLES METALICOS		CERRADEROS EN NYLON			
A-B	C	D	A-B	C	D
06463.08	06463.08 (17)	06465.02			
(17) Inserto para rodillo 06141.71					

PARA LOS DESVIADORES UTILIZAR 2 CERRADEROS DEL GRUPO D  
CILINDRO EUROPERFIL REF. 08310.12.0.12

ENTRADA - 35 mm.

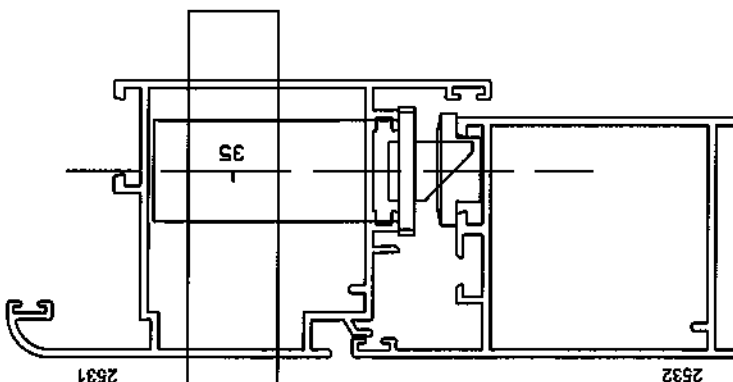

**CERRADURA DE SEGURIDAD MULTIPUNTO**

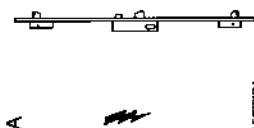

ELECTRICA  
REF. 14625

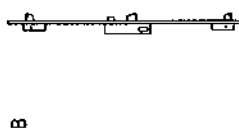

REBILACION REGULABLE + PALANCA  
REF. 44525

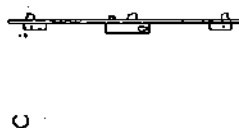

RODILLO REGULABLE + PALANCA  
REF. 44550

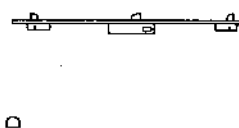

SOLO PALANCA  
REF. 44520

**SERIE S-4045 (Apertura exterior)**

CERRADEROS REGULABLES METALICOS		CERRADEROS EN NYLON			
A-B	C	D	A-B	C	D
06463.08	06463.08 (17)	06465.02			
(17) Inserto para rodillo 06141.71					

PARA LOS DESVIADORES UTILIZAR 2 CERRADEROS DEL GRUPO D  
CILINDRO EUROPERFIL REF. 08310.12.0.12

ENTRADA - 35 mm.

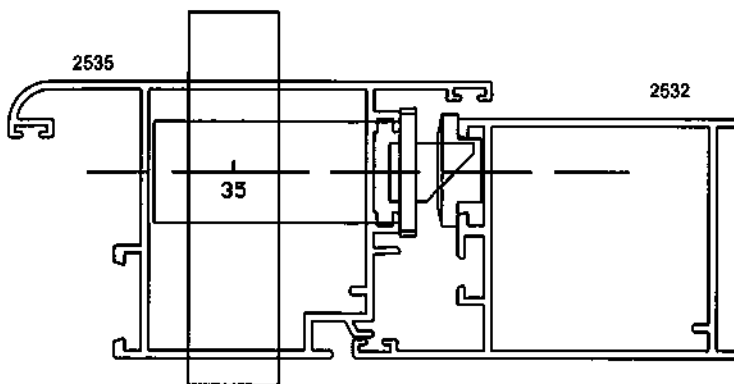

ELECTRICA  
REF. 14525

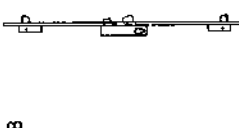

REBILACION REGULABLE + PALANCA  
REF. 44525

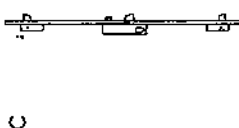

RODILLO REGULABLE + PALANCA  
REF. 44550

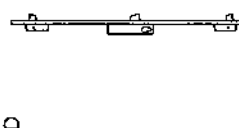

SOLO PALANCA  
REF. 44520

**SERIE S-4045**

CERRADROS REGULARES METÁLCOS		CERRADROS EN NYLON			
A-B	C	D	A-B	C	D
06463.18	06463.18 (17)	06465.02			

(17) Inserto para rodillo 06141.71

PARA LOS DESVIADORES UTILIZAR 2 CERRADROS REF. 06465.12  
CILINDRO EUROPERFIL REF. 6M300.12.0.12

ENTRADA = 35 mm.

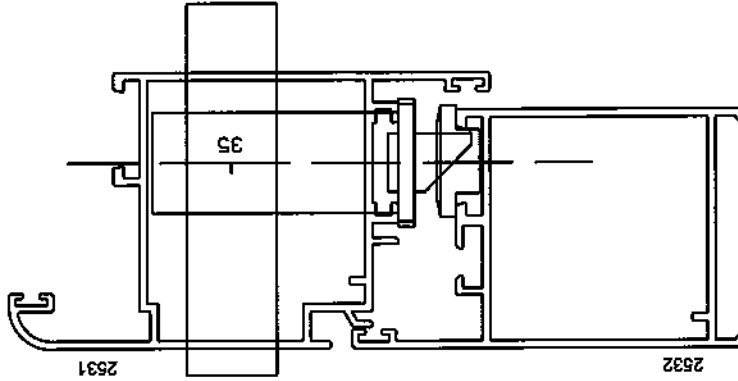

**CERRADURA DE SEGURIDAD ALUMARTE**

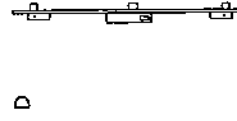
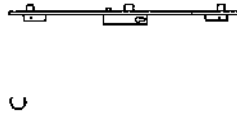
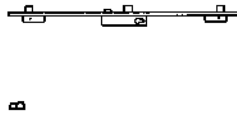
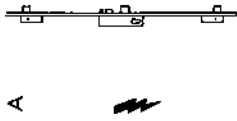

**SERIE S-4045 (Apertura exterior)**

CERRADROS REGULARES METÁLCOS		CERRADROS EN NYLON			
A-B	C	D	A-B	C	D
06463.18	06463.18 (17)	06465.02			

(17) Inserto para rodillo 06141.71

PARA LOS DESVIADORES UTILIZAR 2 CERRADROS REF. 06465.12  
CILINDRO EUROPERFIL REF. 6M300.12.0.12

ENTRADA = 35 mm.

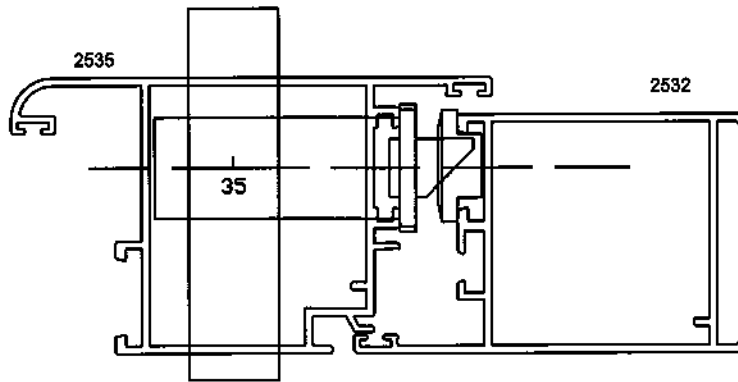

**CERRADURA DE SEGURIDAD ALUMARTE**

