

VENTANA ABISAGRADA SERIE 5050 RT	DIMENSION	RESULTADO			CERTIFICADO
		AIRE	AGUA	VIENTO	
	1200 x 1200 Alumarte	CLASE 4	CLASE E 750	CLASE C 5	ARCO TECNOS
SIMULACIÓN UNE EN ISO 10077-2:2003	COEFICIENTE DE TRANSMISIÓN TÉRMICA	"U" = 3.1		CIDEMCO	

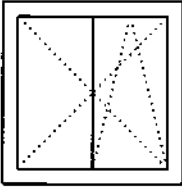

La sección aquí representada es solo la muestra de una tipología dentro de las múltiples variantes.

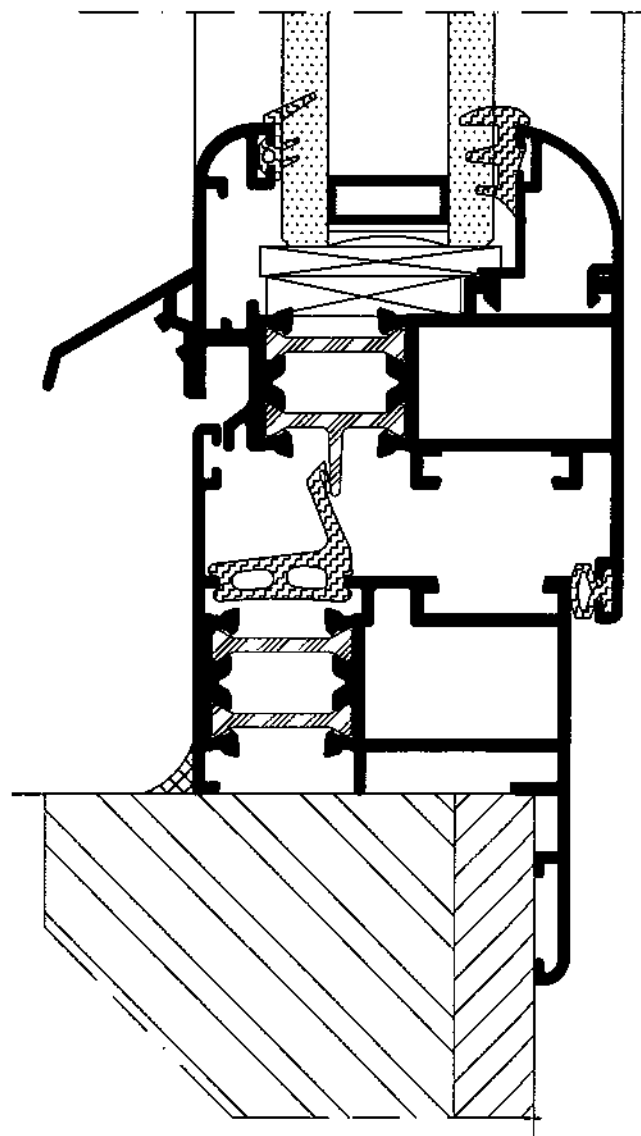

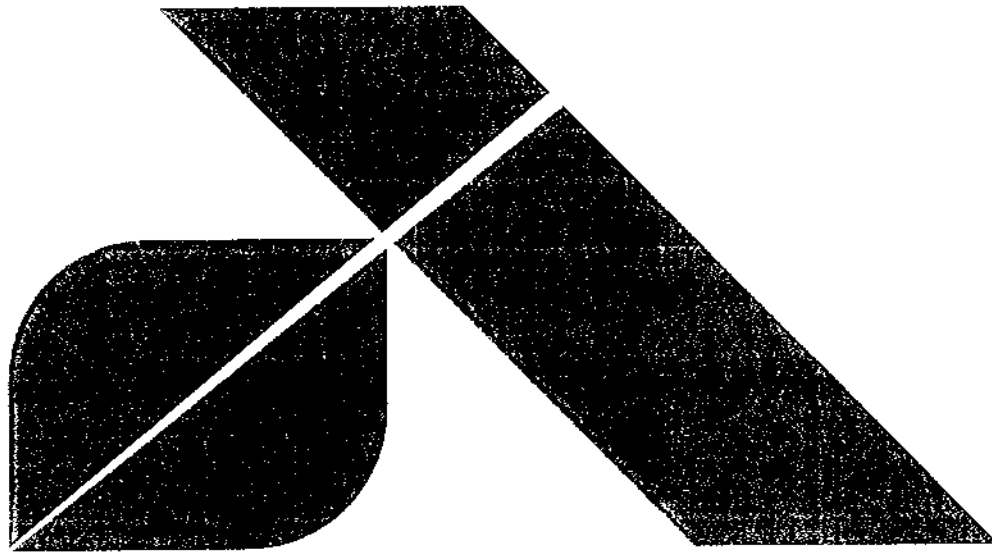
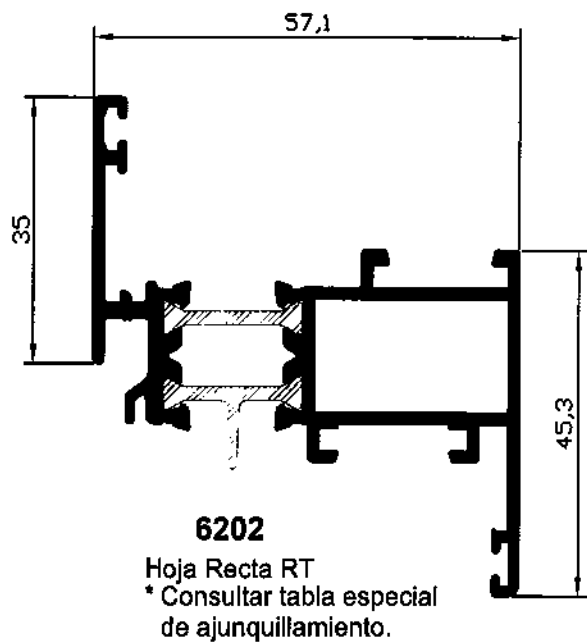
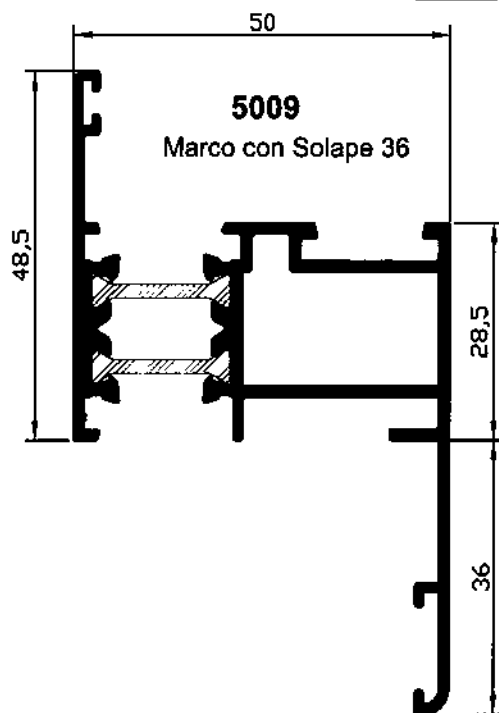
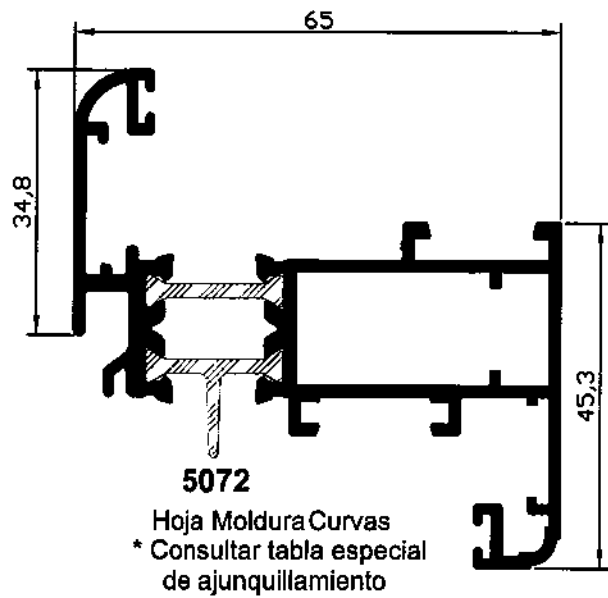
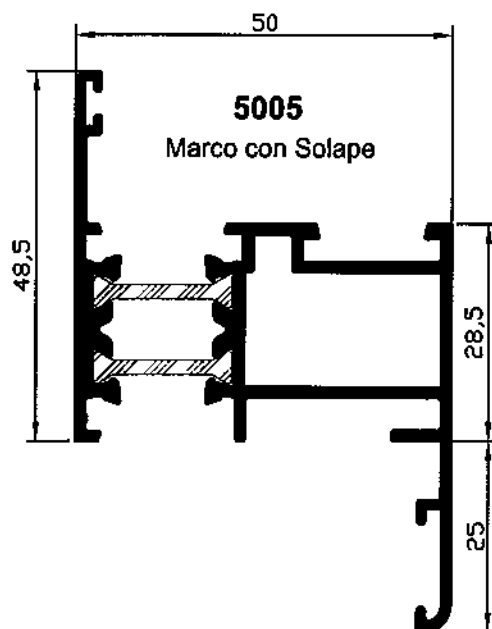
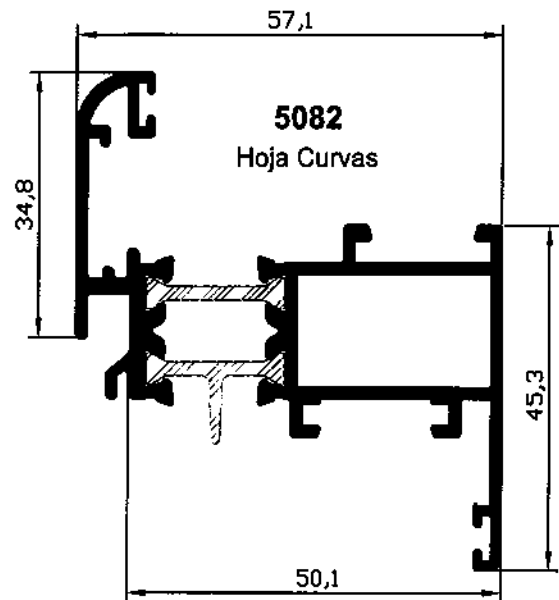
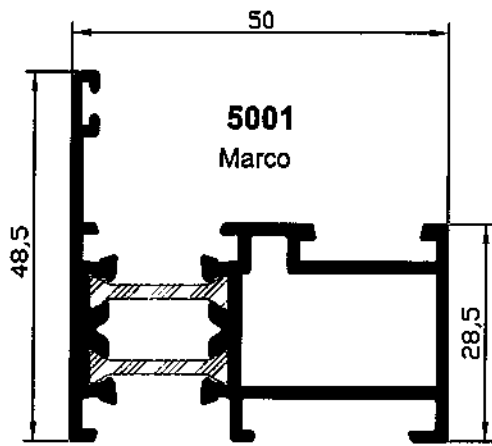

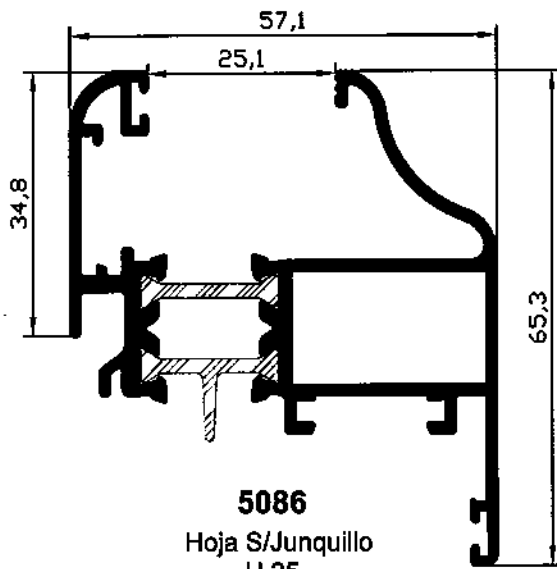

**5086**  
Hoja S/Junquillo  
H 25

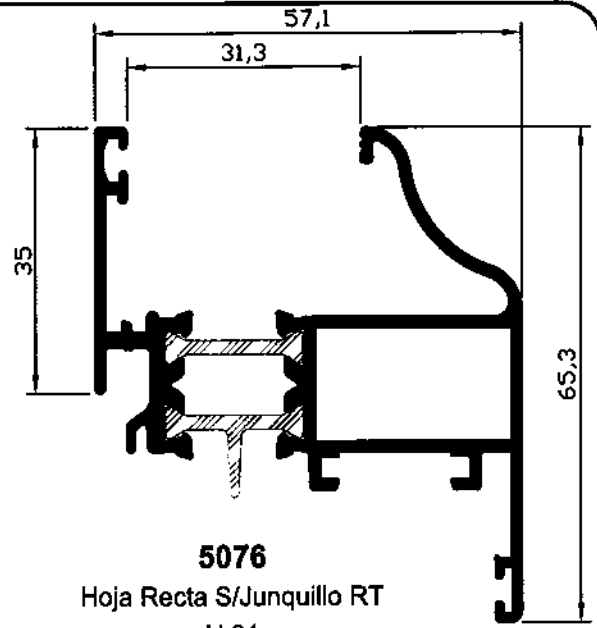

**5076**  
Hoja Recta S/Junquillo RT  
H 31

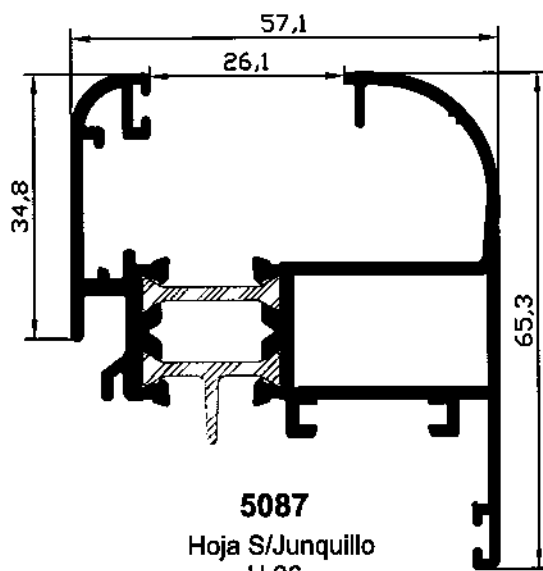

**5087**  
Hoja S/Junquillo  
H 26

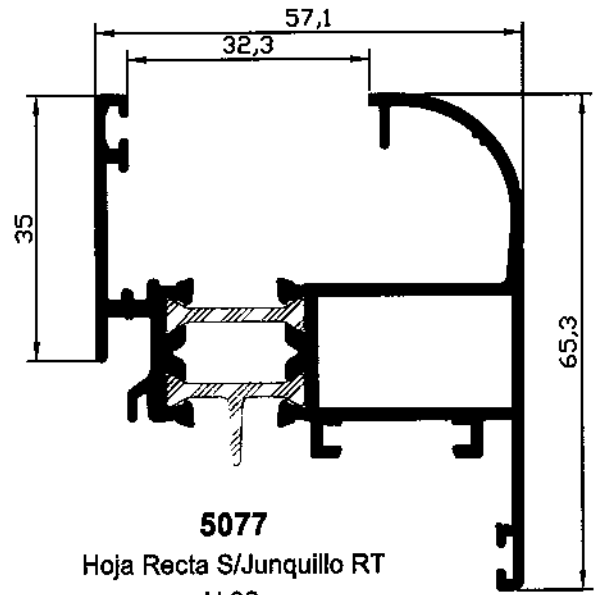

**5077**  
Hoja Recta S/Junquillo RT  
H 32

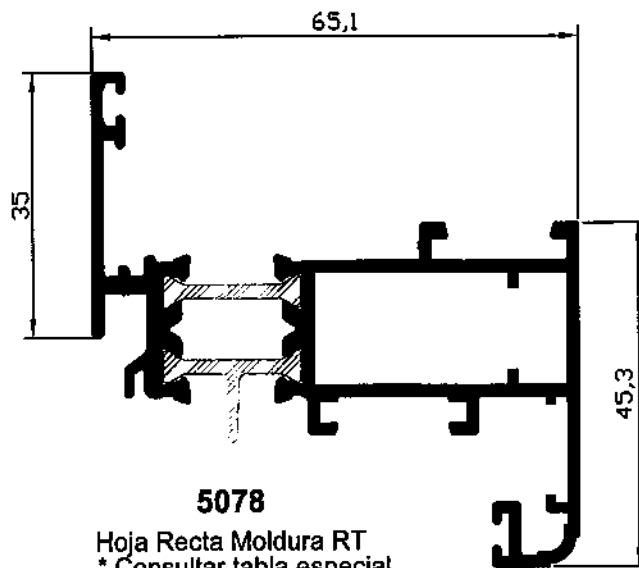



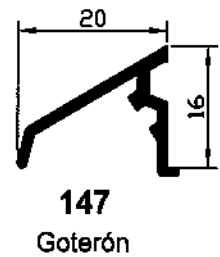
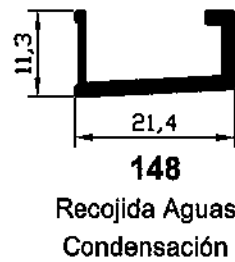
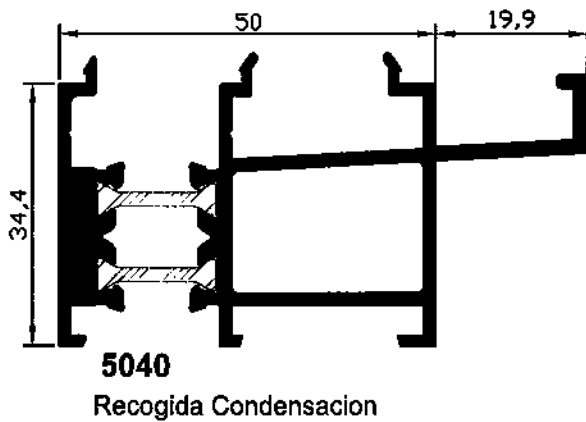
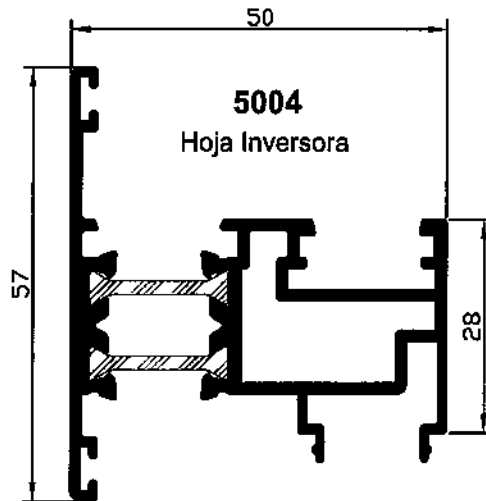
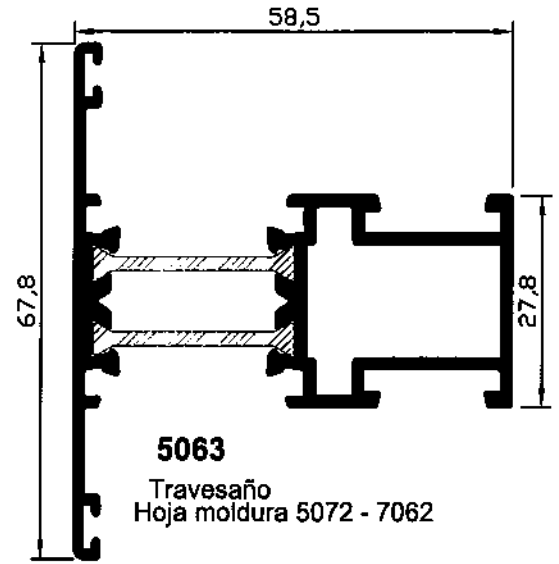
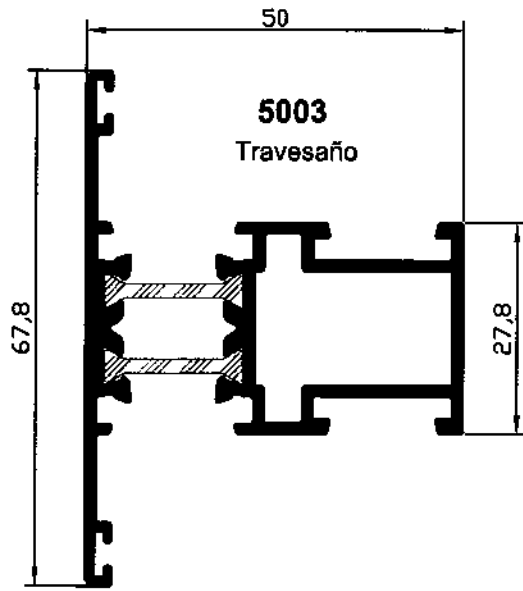

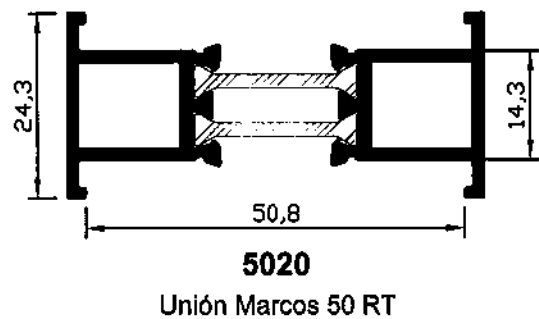
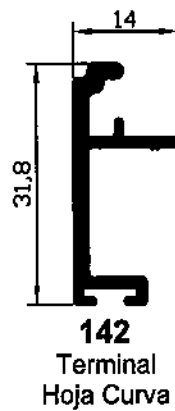
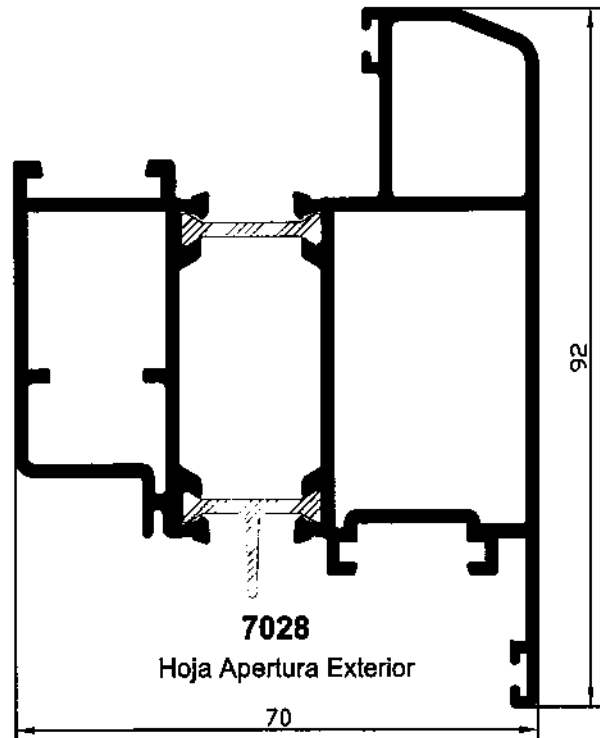
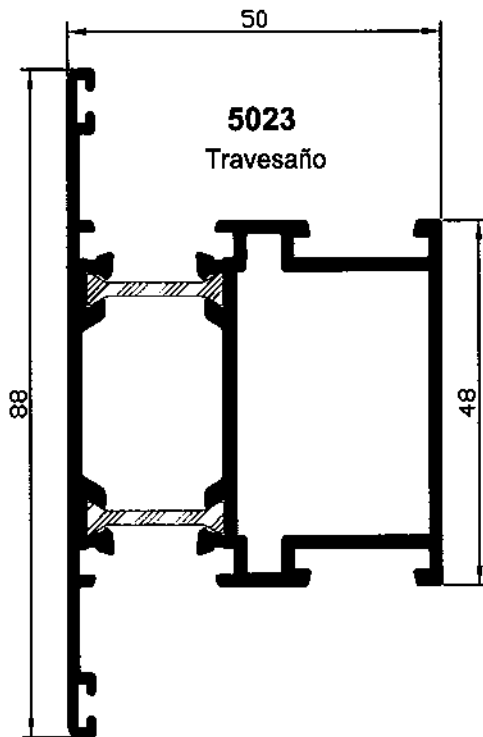
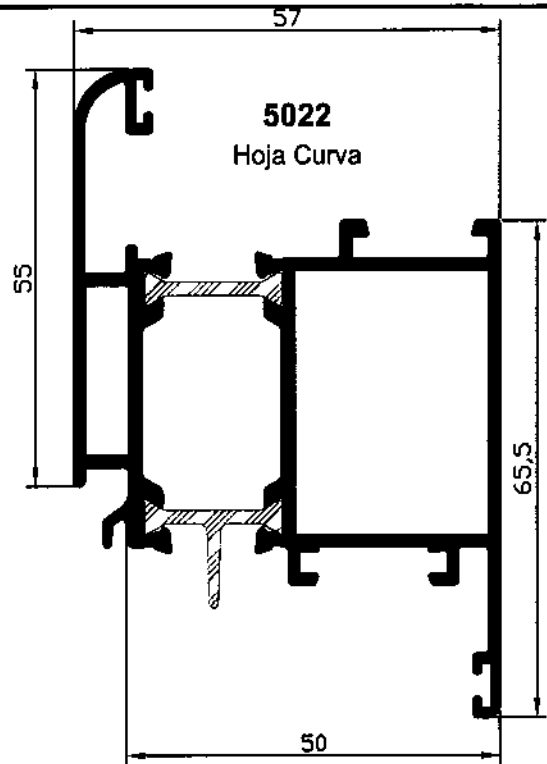
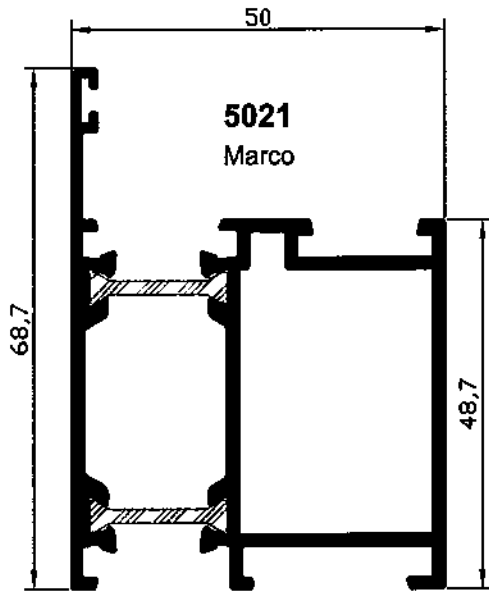

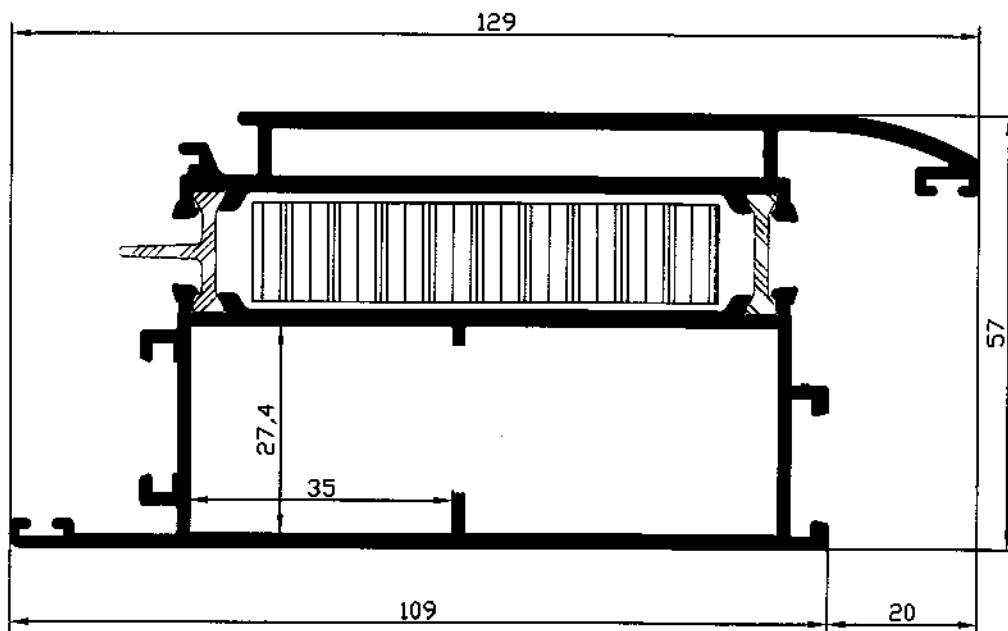
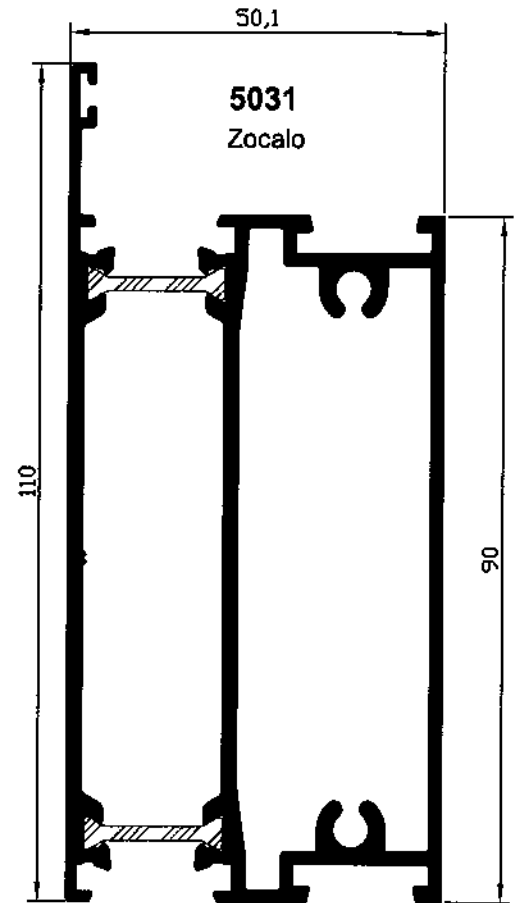
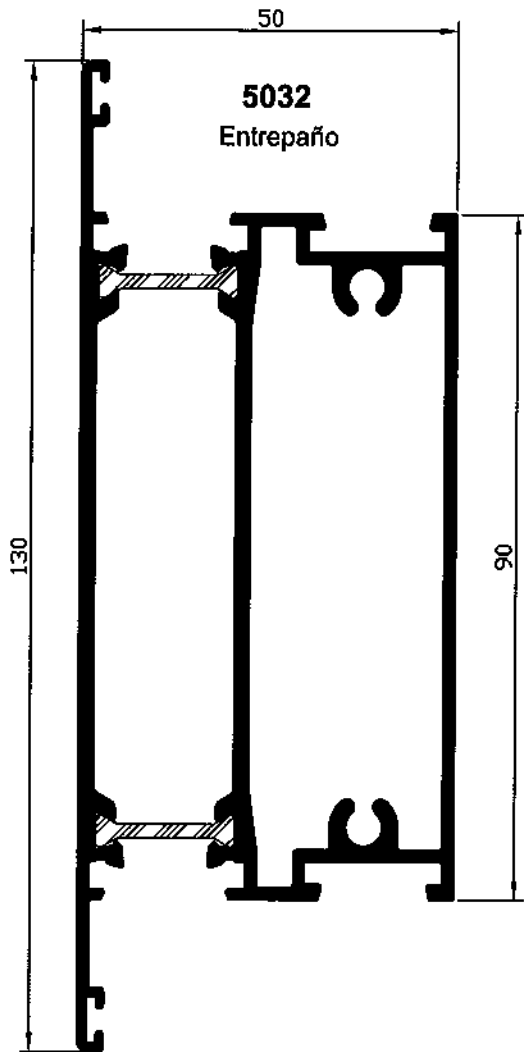



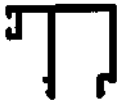

**5078**  
Hoja Recta Moldura RT  
\* Consultar tabla especial  
de ajunquillamiento.







**5029**  
Hoja Puerta 129 mm.

REFERENCIA	MEDIDA JUNQUILLO	MEDIDA HUECO			
		PERFILES SERIE 5050RT	PERFIL 5072	PERFIL 5078	PERFIL 6202
 361	29 mm	17,4	25,6	31,8	23,8
 362	24 mm	22,5	30,6	36,8	28,8
 363	19,5 mm	27	35,1	41,3	33,3
 364	14,5 mm	32	40,1	46,3	38,3
 365	10,5 mm	36	44	50,3	42,3
  371      372	26,4 mm	20	28,2	34,4	26,4
  373      374	22,4 mm	24	32,2	38,4	30,4
  375      376	18,4 mm	28	36,2	42,4	34,4
  377      378	14,4 mm	32	40,2	46,4	38,4



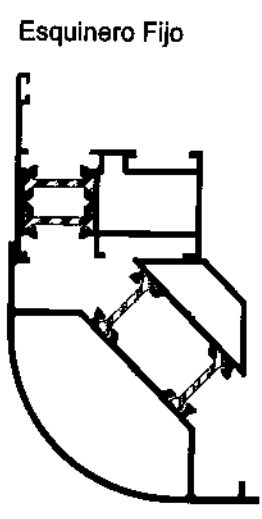
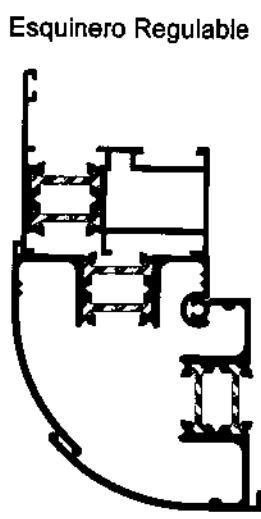
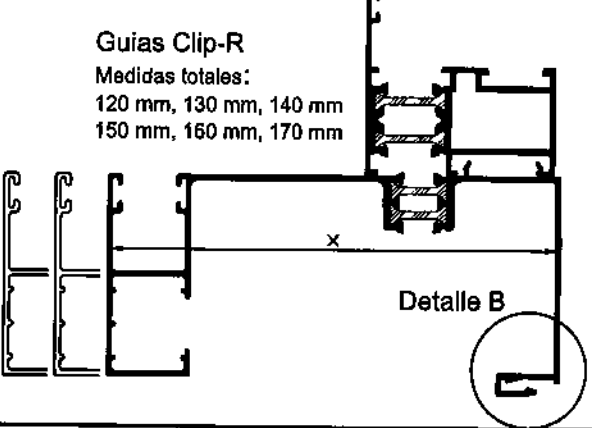
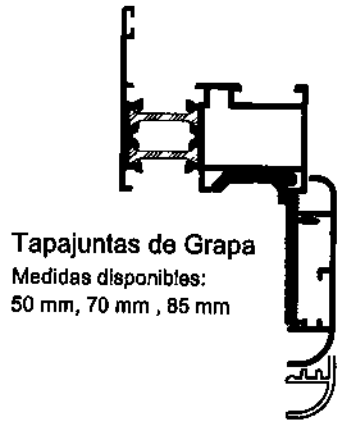
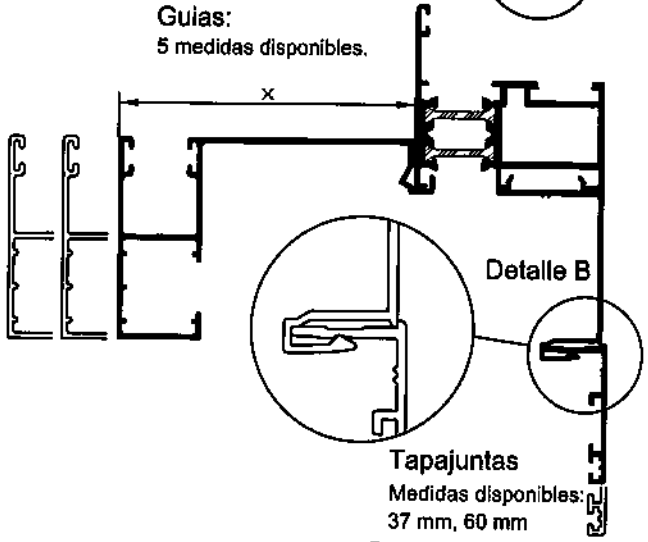
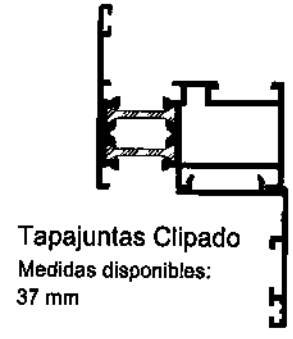
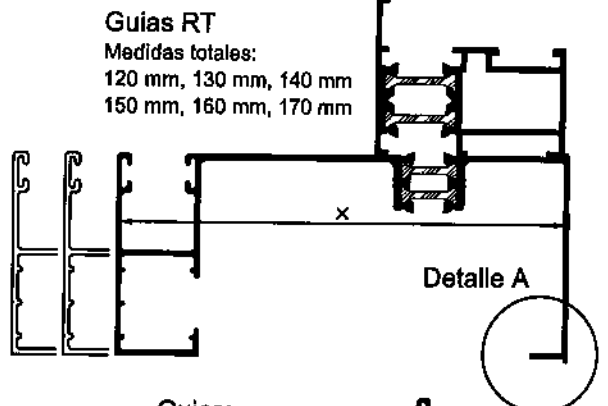
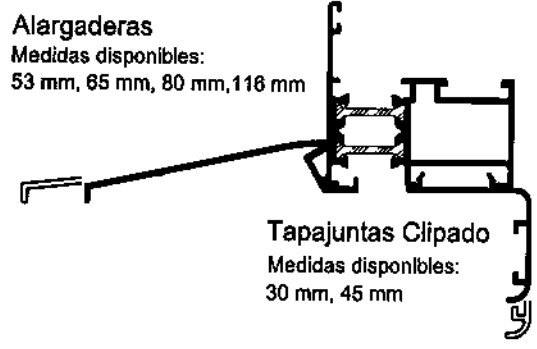
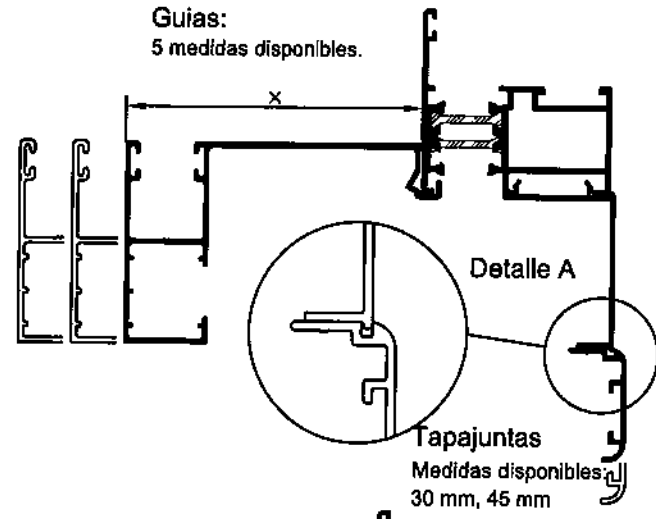

Para mas información de perfiles complementarios, en el apartado **VARIOS** de este catalogo.



## VENTANA 2 HOJAS

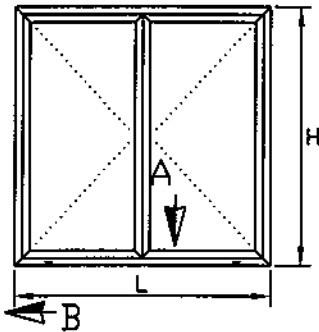

B

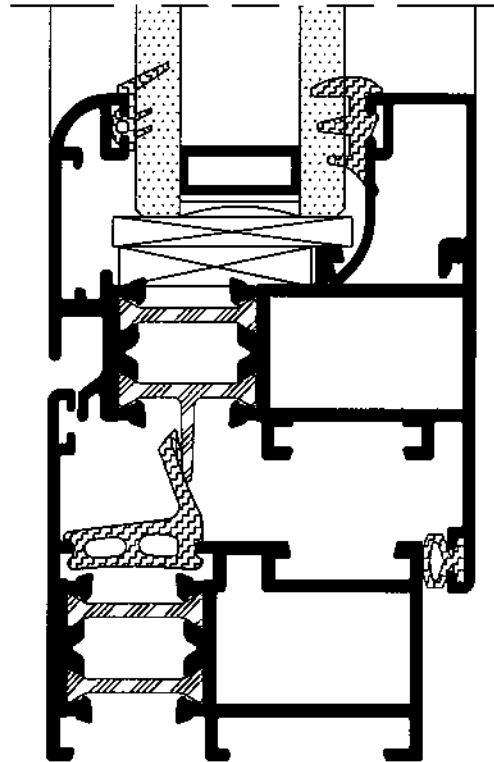

### TABLA DE CORTES

	ANCHURA DE HOJA	ALTURA DE HOJA	ALTURA PERFIL INVERSOR
VENTANA UNA HOJA	L-45	H-45	H-106
VENTANA DOS HOJAS	(L-50)/2		

A

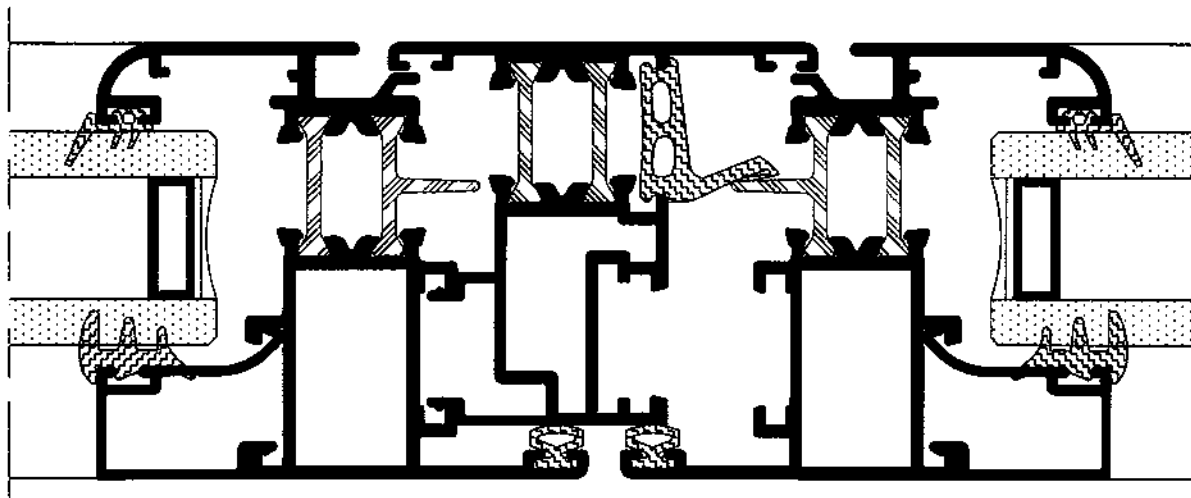

NOTA: LAS MEDIDAS SON ORIENTATIVAS, PUDIENDO VARIAR SEGÚN EL TIPO DE HERRAJE QUE SE UTILICE  
ROGAMOS VERIFIQUEN LAS MEDIDAS ANTES DE CORTAR EL MATERIAL EN SERIE.

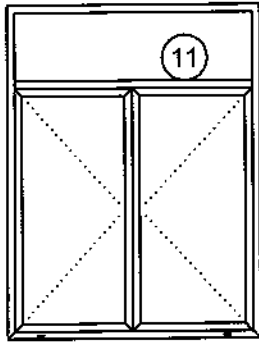

11

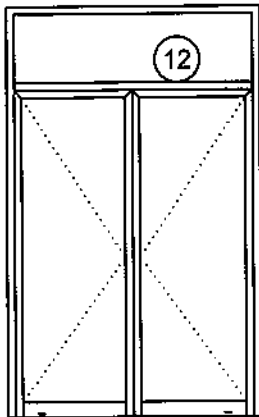
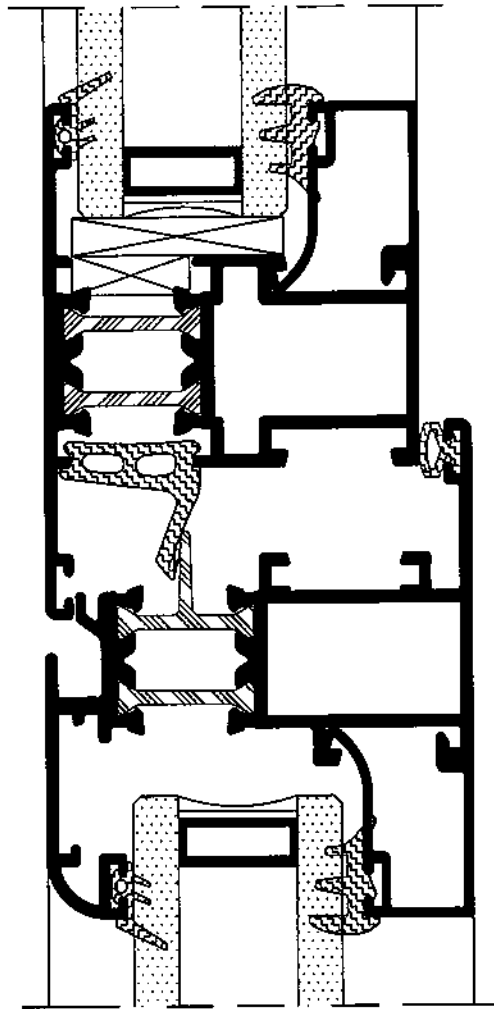

12

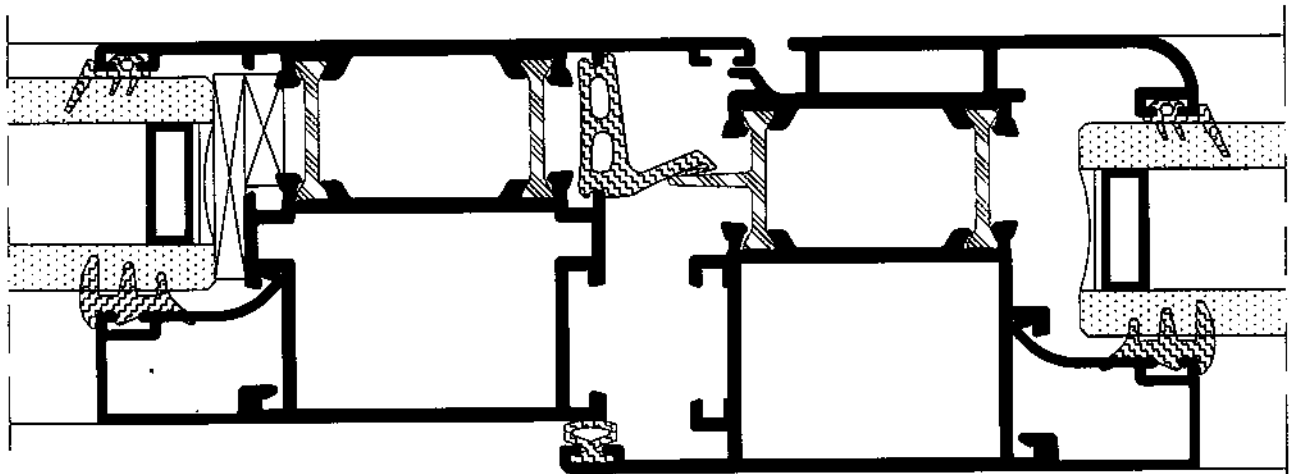

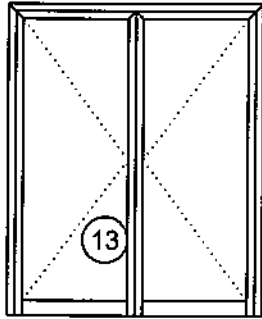

13

TERMINACION HOJA

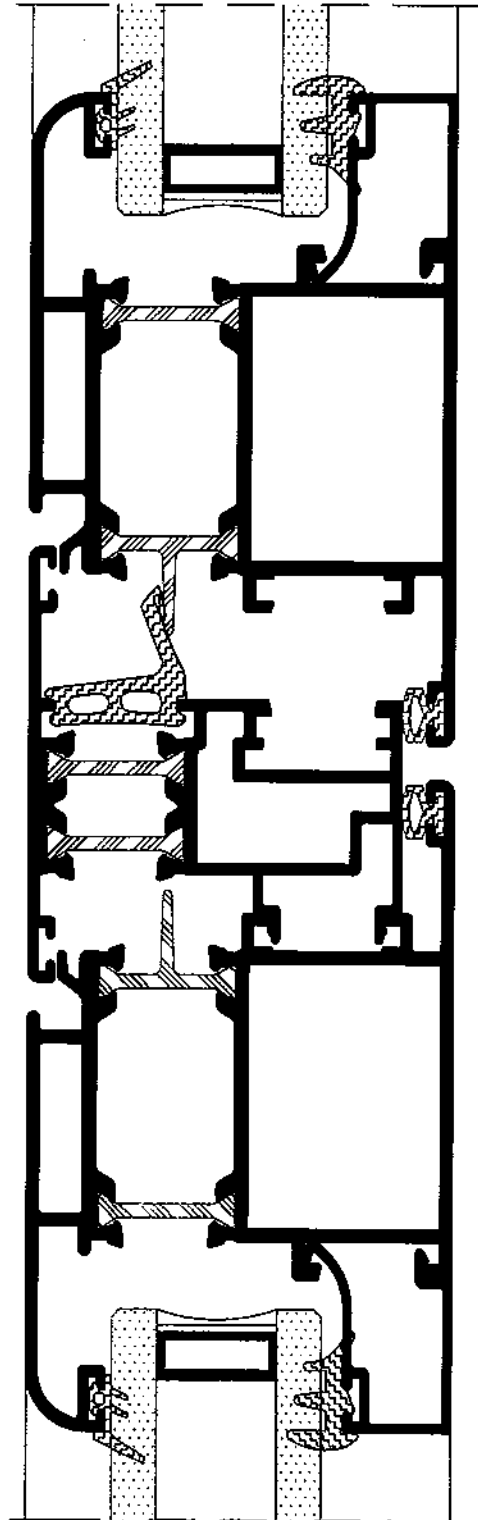
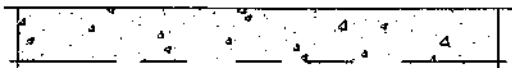
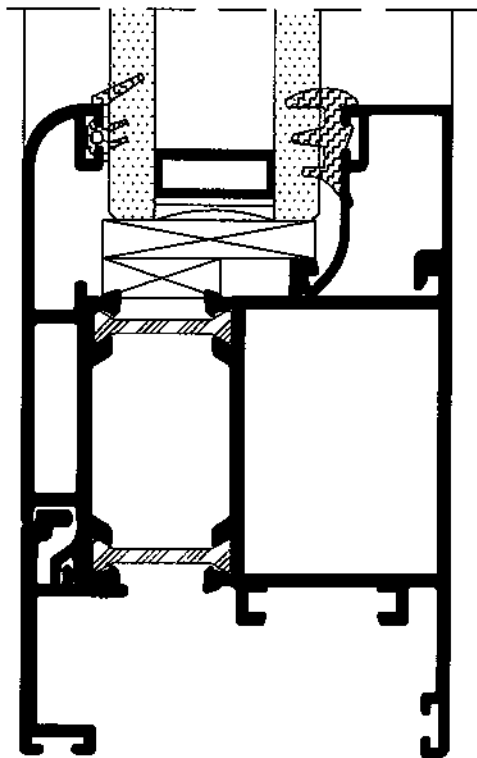

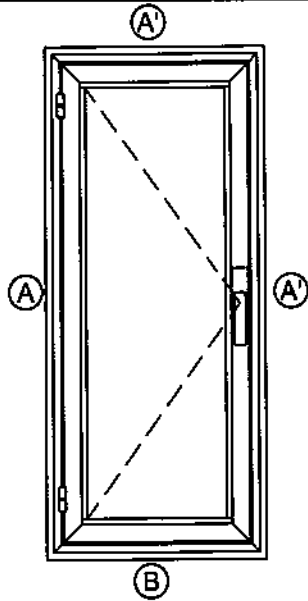

Sección B-A'

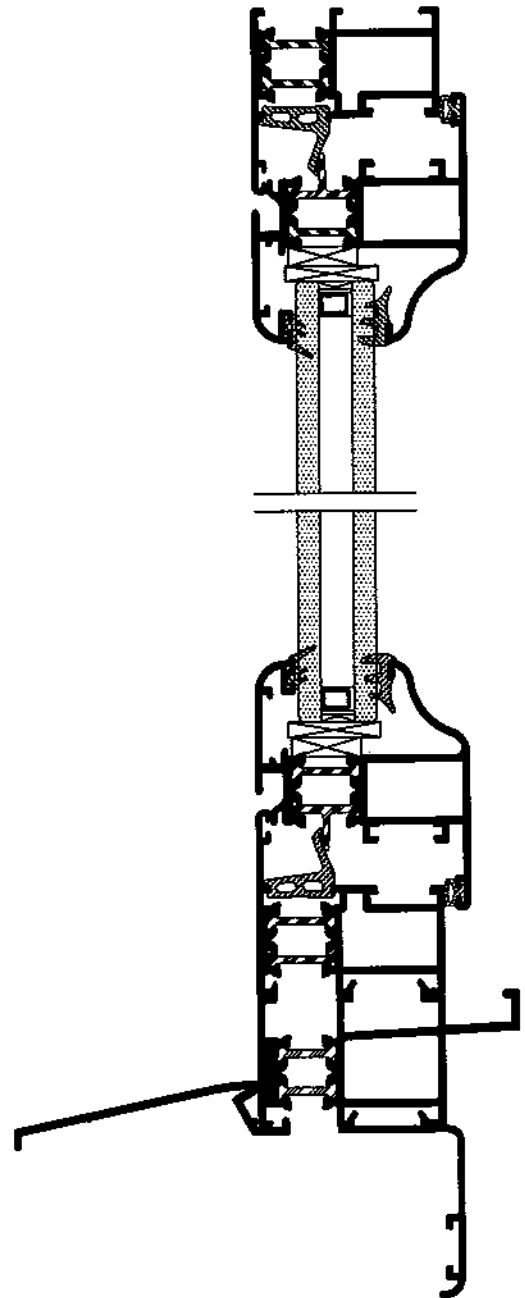

Sección A-A'

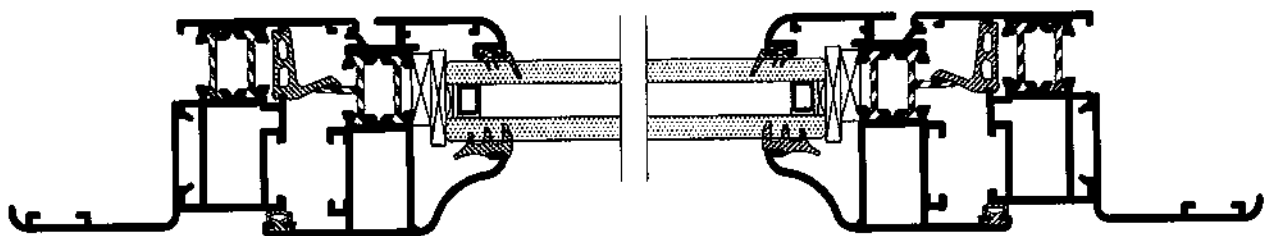

Sección B-A'

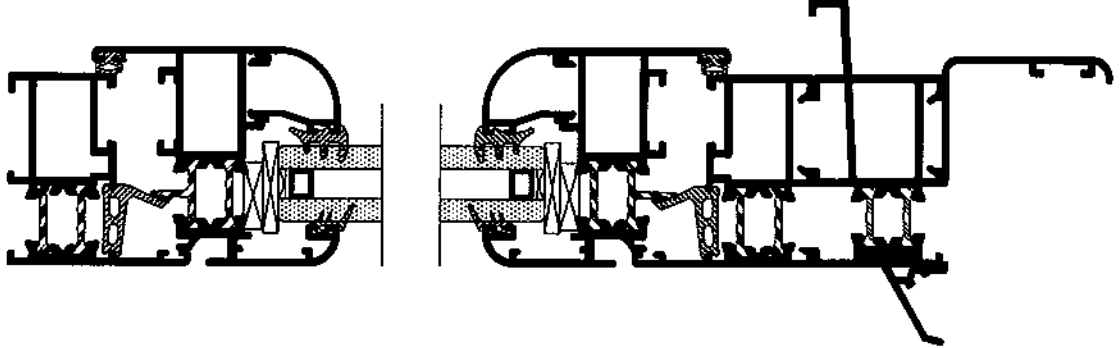

Sección A-C-D

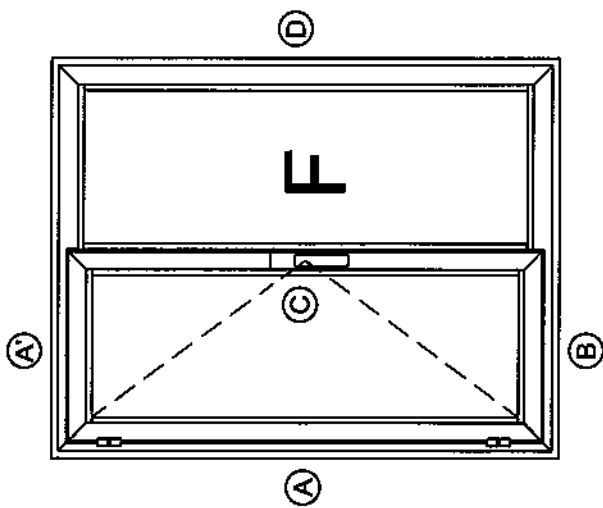
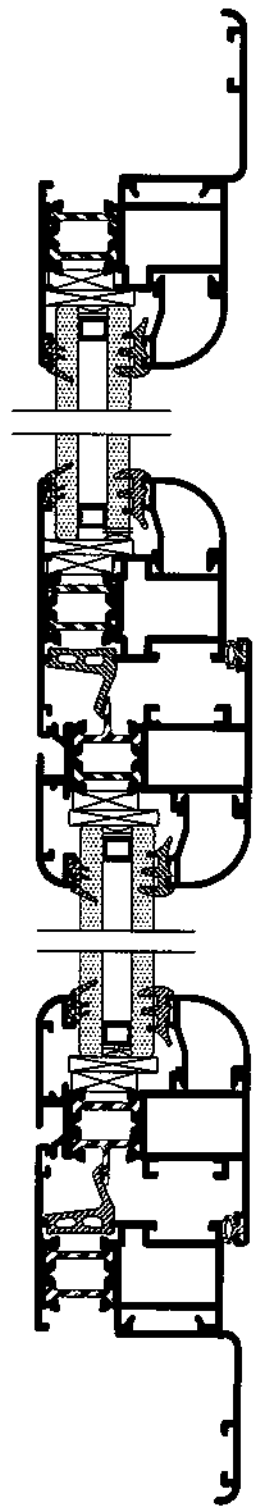

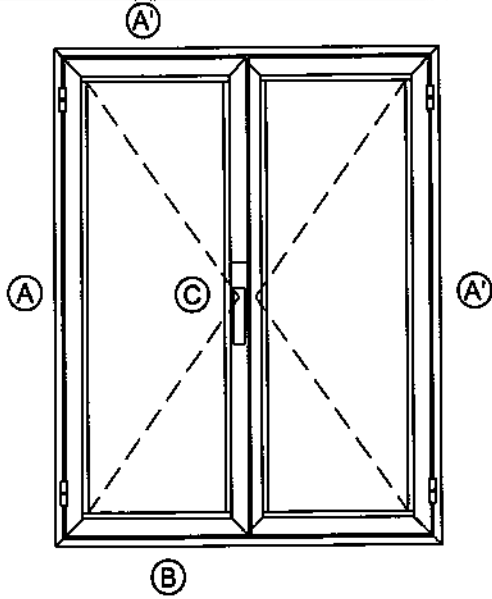

Sección B-A'

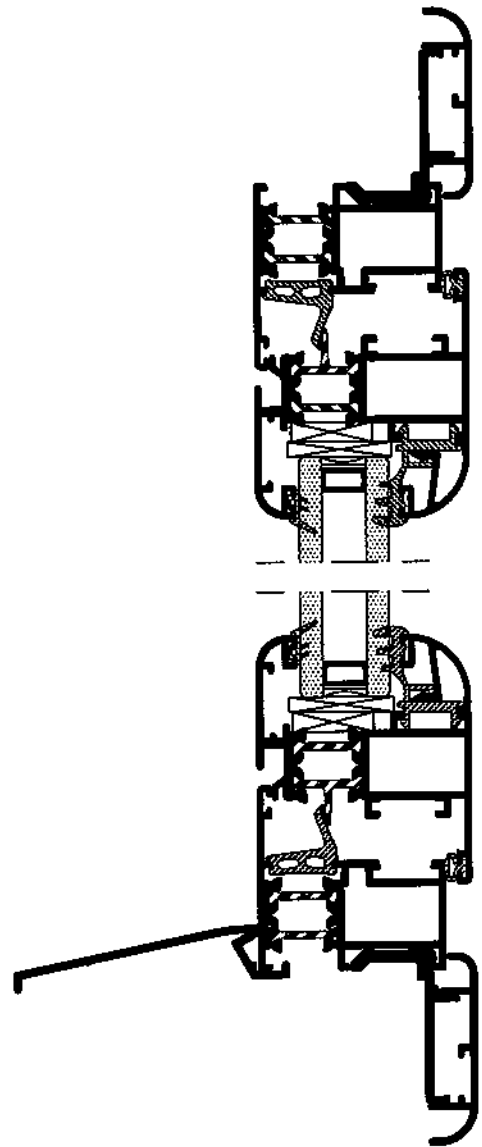

Sección A-C-A'

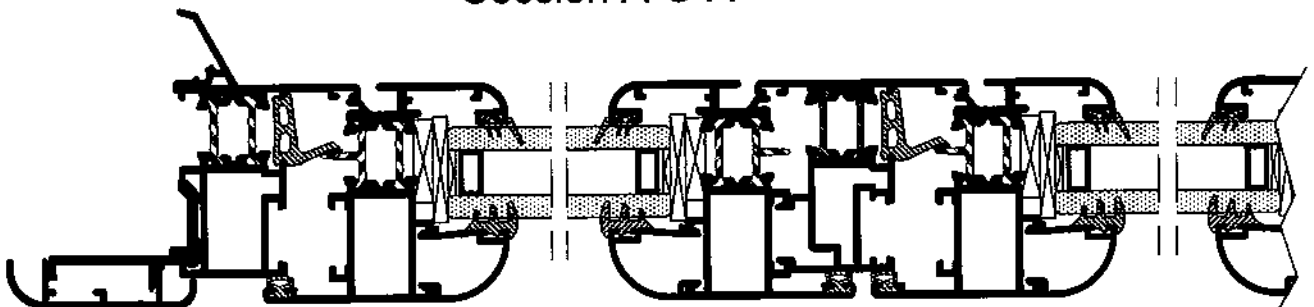



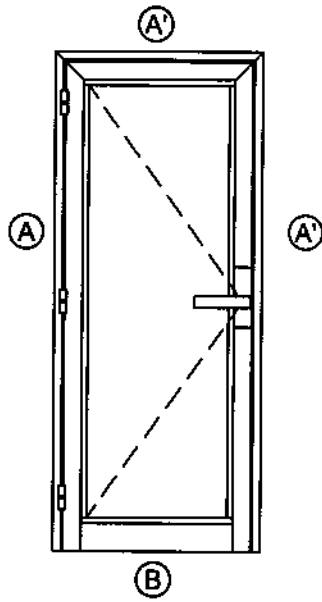

Sección B-A'

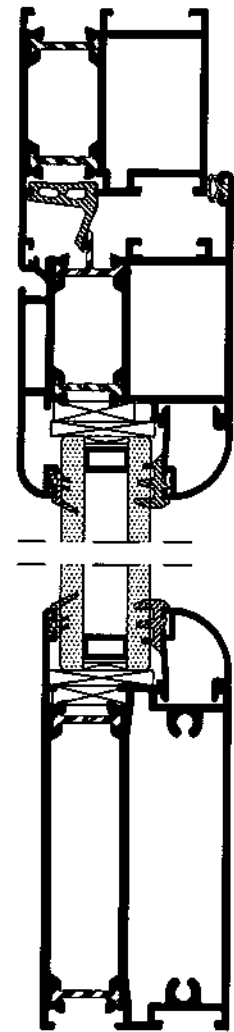

Sección A-A'

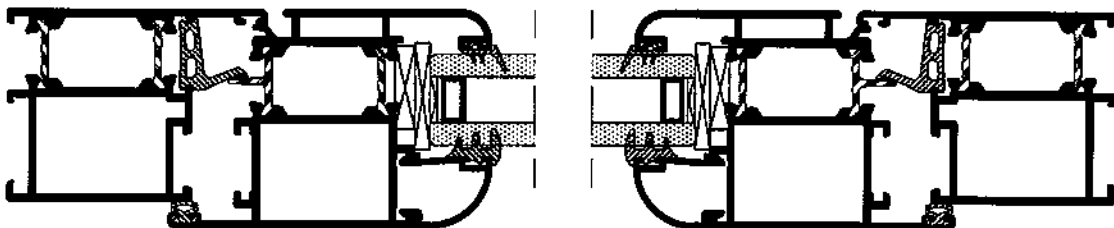

### Sección B-A'

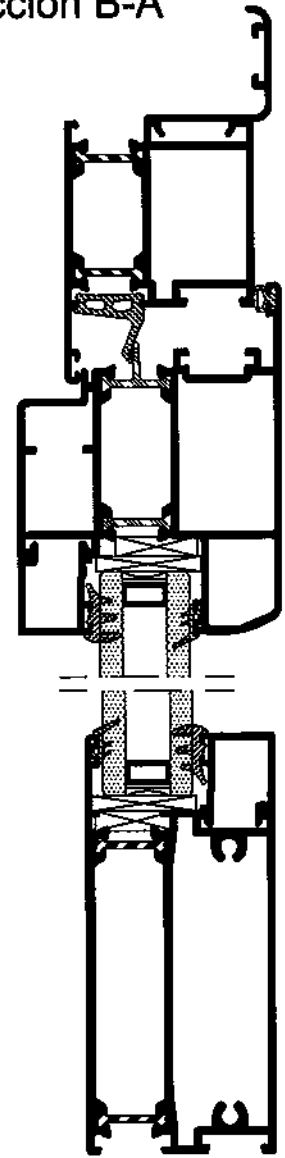
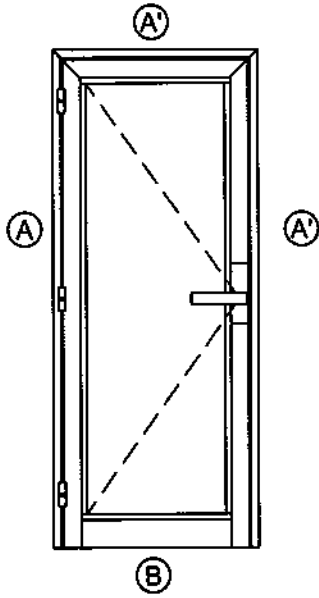

### Sección A-A'

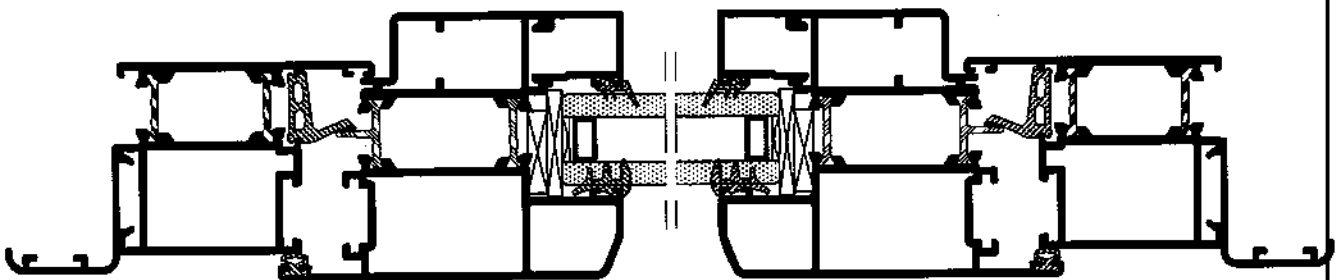

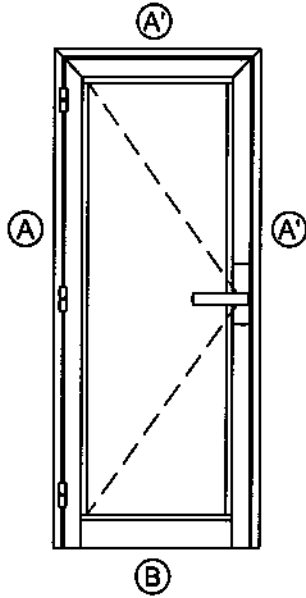

Sección B-A'

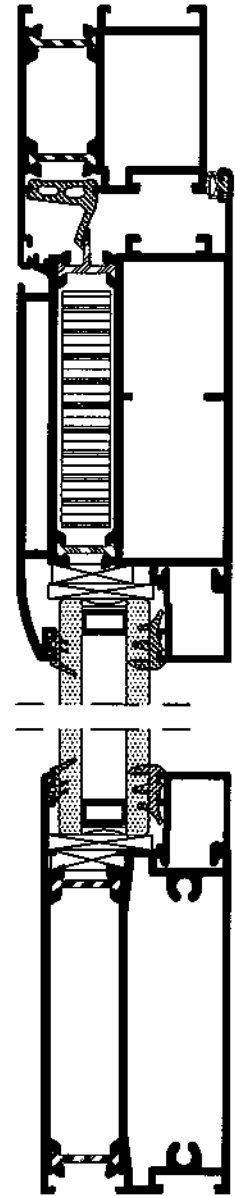

Sección A

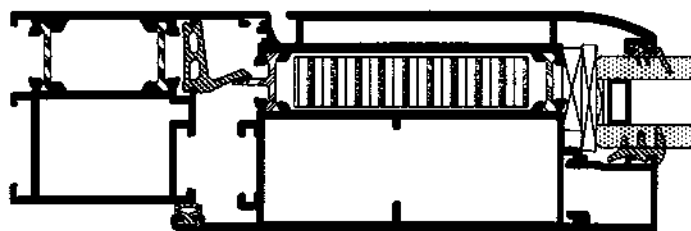

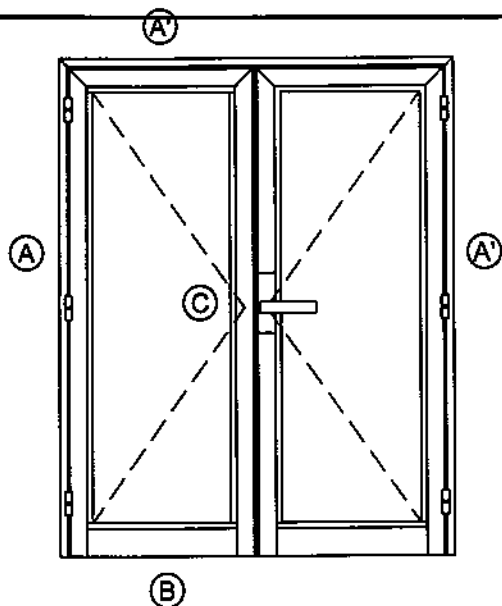

Sección B-A'

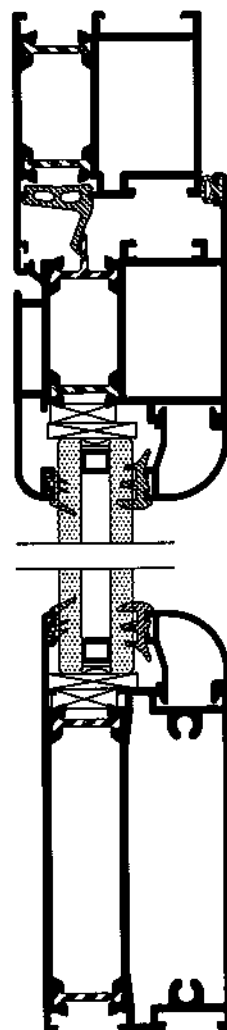

Sección B-A'

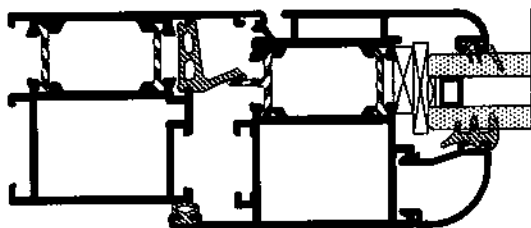

Sección B-A'

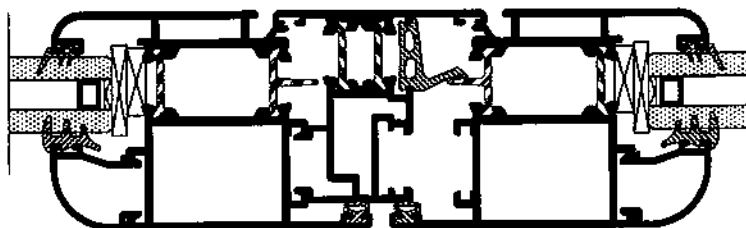

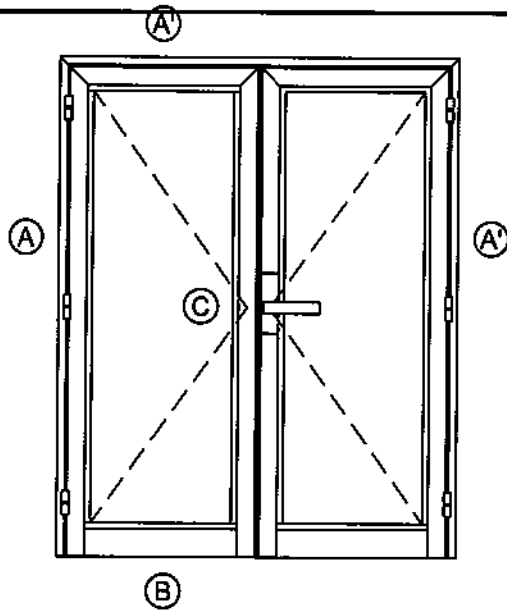

Sección B-A'

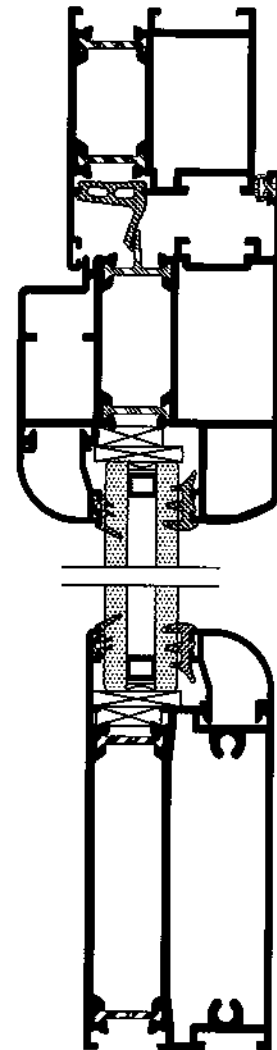

Sección A

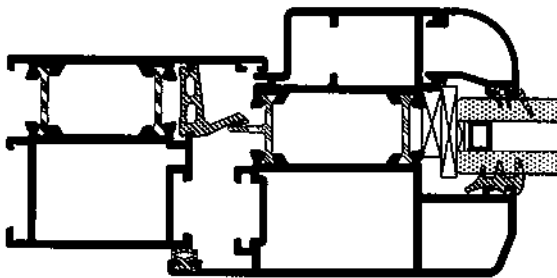

Sección C

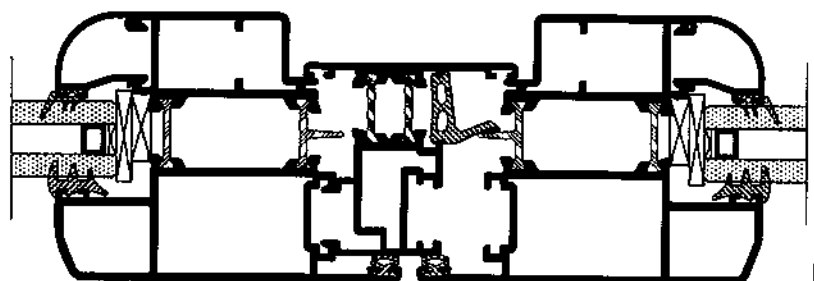

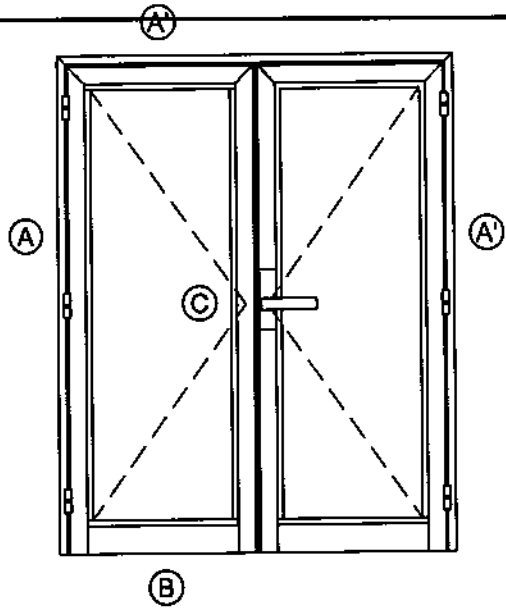

Sección B-A'

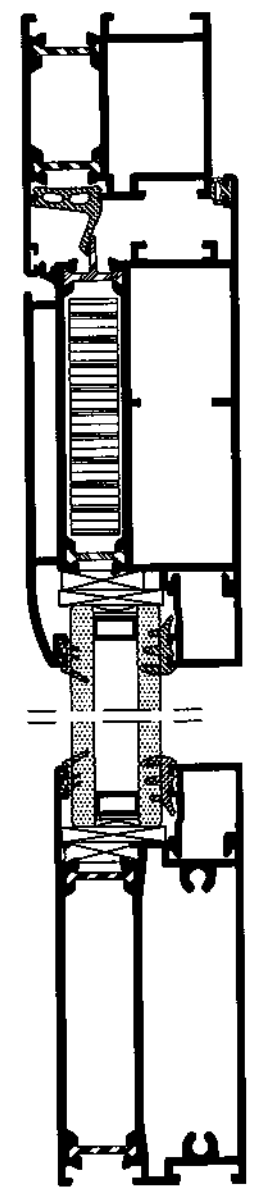

Sección A

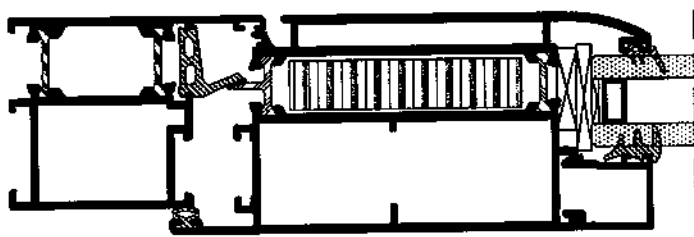

Sección C

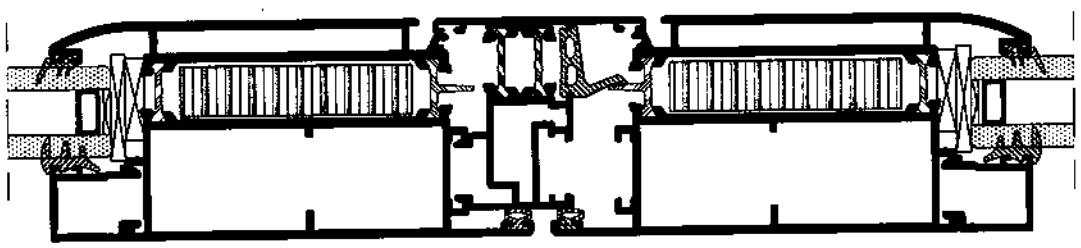



CR1574xx

Cremona normal primo



CR1674xx

Cremona O/B primo



CR1774xx

Cremona unica apertura exterior



CR1874xx

Cremona O/B primo key

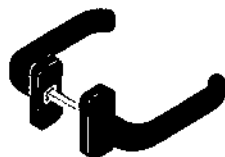

V8974xx

Manilla flora (pareja)



B2728xx

Bisagra puerta C.E.



B3074xx Dch  
B3174xx Izq

Bisagra flash premontada



B3274xx

Bisagra domino HP3 atas

K437400



Kit 1 hoja batiente

K467400



Kit 2 hojas batiente

K4474xx



Kit O/B futura 3D

B427400



Kit O/B 2ª hoja futura 3D

V287400



Pasador a suelo GIAP futura

V837400



Pasador O/B 2ª hoja GIAP

V857400



Pasador 2ª hoja bidireccional a leva

V807400



Compas O/B futura 550-1700

V817400



Compas O/B futura 390-550

V867400



Encuentro simple ZAMAK GIAP y tercer punto

V887400



Encuentro doble ZAMAK GIAP

V1037400



Encuentro regulable simple





**E030200**

Escuadra bloqueo 26x14  
Ventana



**E040200**

Escuadra bloqueo 26x36  
Puerta

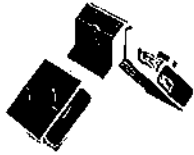

**E540200**

Escuadra muelle S-RT  
Ventana



**E610200**

Escuadra muelle S-RT  
Puerta



**E110200**

Escuadra bloqueo hoja  
apertura exterior 26x4  
S-7070



**E342700**

Escuadra alineación M-H-T  
PVC



**E352700**

Escuadra alineación hoja



**E590200**

Escuadra alineación marco  
carril goma



**E630900**

Escuadra alineación exterior  
hoja S-5050 RT



**E672200**

Escuadra alineación larga  
tras burbuja



**E690200**

Escuadra alineación ext. fija  
hoja S-5050



**E140700**

Escuadra graduable S-RT  
Ventana



E230200

Unión travesaño puerta  
35mm



G250200

Unión travesaño ventana  
14mm



TP012700

Tapa inversora S-RT blanda  
(Juego)



V0127xx

Salida aguas



TP052700

Tapa inversora perfil 7004  
(Juego)



TP0866xx

Tapa recogida condensación  
perfil 148 (Juego)



V044600

Grapa junquillos series  
abisagradas



IGR505000

Grapa tapajuntas



V1047400

Compas retenedor abatible  
H=250-500



V1057400

Compas retenedor abatible  
H=350-2000



V2863xx

Golpete grande C.E.

### Legenda de Colores de Accesorios:

01 - Blanco      02 - Negro  
03 - Oro        06 - Plata

Ejemplo:  
Referencia base: B3074xx  
Referencia blanco: B307401

Consultar colores disponibles en tarifa.



G257500

Goma central S-RT EPDM



G021700

Goma cuña pequeña E4



G031700

Goma cuña grande E6



G091700

Goma acristalar perfil EPDM E4



G140300

Goma acristalar dura  
60JBT23 E4



G147500

Goma para fijos S-RT



G217500

Goma burbuja EPDM doble  
dureza



G227500

Goma acristalar perfil EPDM  
doble acustica E3



G237500

Goma acristalar perfil EPDM  
acustica E3



Juego de fresas

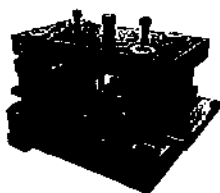

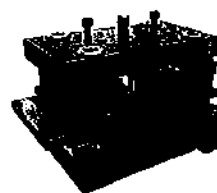

Troquel series abisagradas  
muelle



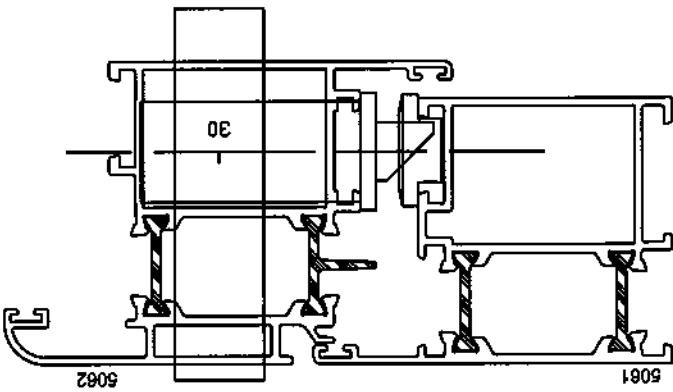

Troquel series abisagradas  
bloqueo

**SERIE S-5050 RT**

CERRADURA DE SEGURIDAD	CERRADERO REGULABLE METALICO	CERRADERO EN NYLON	
A	ELECTRICA SOLO MEBALON REF. 16205	A-B-C 06463.08 D 06463.08 (17)	E-F 06465.02 D E-F
B	ELECTRICA MEBALON + PALANCA LATERAL REF. 16215 TRIPLE REF. 16225	<b>CILINDRO EUROPERFIL REF. 08310.11.0.12</b>  <b>ENTRADA = 30 mm.</b>	
C	MEBALON + REGULABLE + PALANCA LATERAL REF. 46215 TRIPLE REF. 46225		
D	TRIPLE REGULABLE + PALANCA LATERAL REF. 46230 TRIPLE REF. 46250		
E	SOLO PALANCA LATERAL REF. 46210 TRIPLE REF. 46220		
F	 PARRA DESVIADORES LATERALES REF. 06443.00		

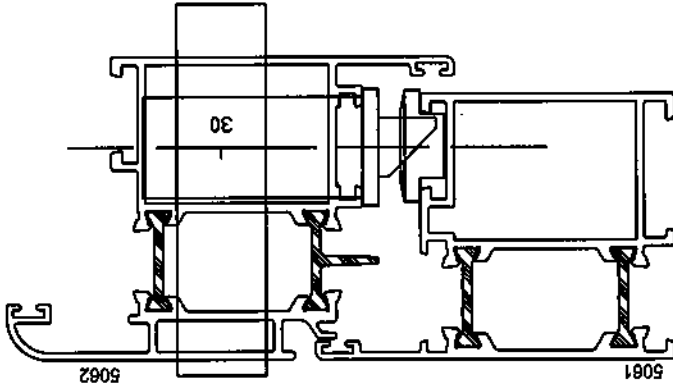
**SERIE S-5050 RT**

CERRADURA DE SEGURIDAD SISTEMA DE ENCRANAJES	CERRADERO REGULABLE METALICO	CERRADERO EN NYLON	
A	ELECTRICA MEBALON REGULABLE + PALANCA LATERAL 3 PILES REF. 18225	A-B 06463.18 C 06463.18 (17) D 06465.02 (17)	D
B	MEBALON REGULABLE + PALANCA LATERAL 3 PILES REF. 48225	<b>PARA LOS DESVIADORES UTILIZAR 2 CERRADEROS REF. 06465.12</b> <b>CILINDRO EUROPERFIL REF. 6M300.11.0.12</b>  <b>ENTRADA = 30 mm.</b>	
C	TRIPLE REGULABLE + PALANCA LATERAL 3 PILES REF. 48250		
D	SOLO PALANCA LATERAL 3 PILES REF. 48220		
E	 PARRA DESVIADORES LATERALES REF. 06443.20		

**SERIE S-5050 RT**

CERRADEROS REGULABLES METÁLICOS		CERRADEROS EN NYLON			
A-B	C	D	A-B	C	D
06463.06	06463.08 (17)	06465.02			

(17) Inserto para rodillo 06141.71

PARA LOS DESVIADORES UTILIZAR 2 CERRADEROS DEL GRUPO D  
CILINDRO EUROPERFIL REF. 08310.11.0.12

ENTRADA = 30 mm.

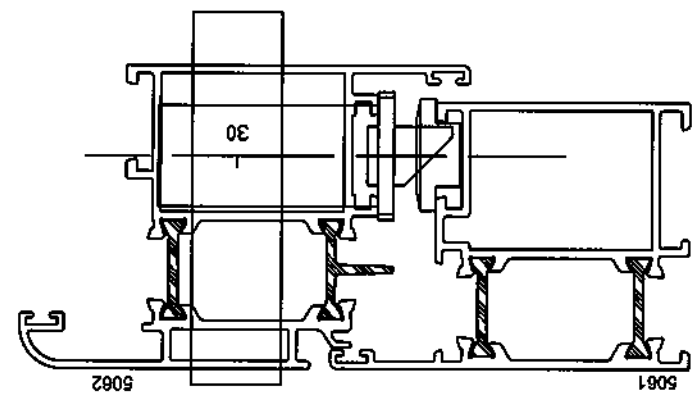

**A**

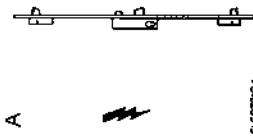

CERRADURA DE SEGURIDAD MULTIPUNTO  
REF. 16325

**B**

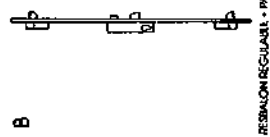

RESILION REGULABLE - PALANCA  
REF. 46525

**C**

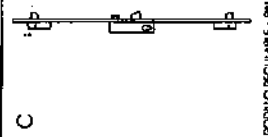

RODILLO REGULABLE - PALANCA  
REF. 46550

**D**

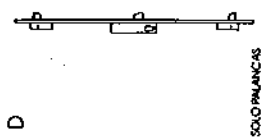

SOLO PALANCA  
REF. 46500

**SERIE S-5050 RT**

CERRADEROS REGULABLES METÁLICOS		CERRADEROS EN NYLON			
A-B	C	D	A-B	C	D
06463.18	06463.18 (17)	06465.02			

(17) Inserto para rodillo 06141.71

PARA LOS DESVIADORES UTILIZAR 2 CERRADEROS REF. 06465.12  
CILINDRO EUROPERFIL REF. 0M300.11.0.12

ENTRADA = 30 mm.

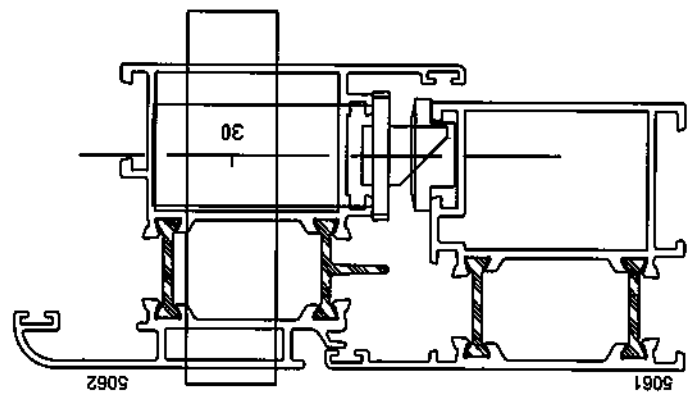

**A**

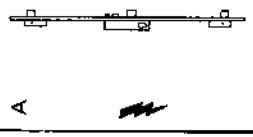

RESILION  
REF. 18525

**B**

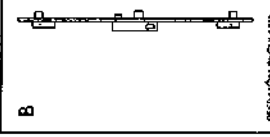

RESILION REGULABLE - PALANCA  
REF. 48525

**C**

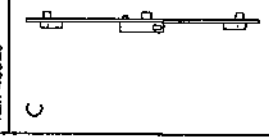

RODILLO REGULABLE - PALANCA  
REF. 48550

**D**

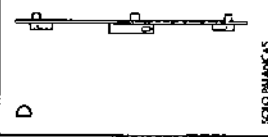

SOLO PALANCA  
REF. 48520

